

A close-up photograph of a silver-colored metal door closer system. The main body is a long, rectangular bar with a brushed metal finish. A smaller, perforated metal component is attached to the end. A semi-transparent white box is overlaid on the image, containing the text "TS 93" and a horizontal line. The DORMA logo is embossed on the side of the main bar.

TS 93

---

Cam action door closer system  
in Contur Design

## VERSATILE AND ELEGANT



The TS 93 cam action door closer system provides a high-quality architectural solution for all project application requirements. The proven DORMA technology featuring the heart-shaped cam ensures exceptional ease of opening.

The new Contur design offers an even more impressive specification - thanks to

- concealed fixings
- height-adjustable G-N slide channel
- delayed closing action as standard
- smoke detector integrated in the slide channel
- simple, fast installation

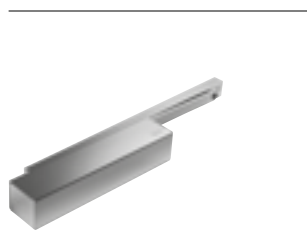

TS 93 N



TS 93 EMF

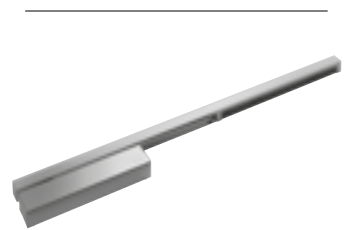

TS 93 EMR

### Rapidly decreasing opening force

The TS 93 system's unique cam technology sets it apart from conventional door closer systems.

The resistance encountered when opening the door is instantly reduced, offering an

easy opening action much appreciated by, in particular, children and older people.



### Force profile

DORMA TS 93 (Spring strength EN 5)

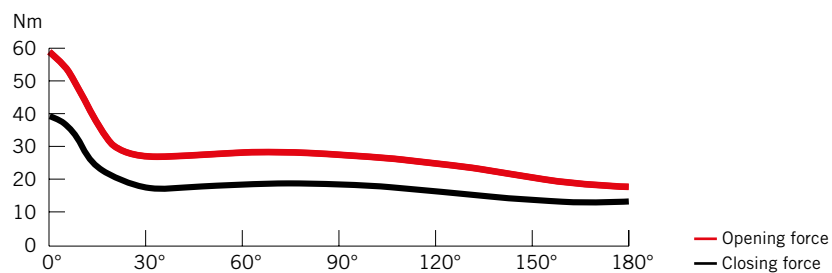

# CONTENTS

---

|  |   |    |
|--|---|----|
| Cam action door closer system                    | <b>Features and functions</b>   | 4  |
| Door closer                                      | <b>TS 93 B</b><br>Door closer for pull-side door leaf fixing/<br>push-side transom fixing   | 6  |
|  | <b>TS 93 G</b><br>Door closer for push-side door leaf fixing/<br>pull-side transom fixing   | 7  |
| Slide channel for Single doors                   | <b>G-N</b><br>Standard slide channel design   | 8  |
|  | <b>RF</b><br>Hold-open unit   | 8  |
|  | <b>G-EMF</b><br>Slide channel with electro-mechanical hold-open   | 10 |
|  | <b>G-EMR</b><br>Slide channel with electro-mechanical hold-open<br>and integral smoke detector  | 12 |
| Door co-ordinator slide channel for Double doors | <b>G-SR</b><br>Door co-ordinator slide channel for pull-side fixing   | 14 |
|  | <b>G-SR-EMF</b><br>Door co-ordinator slide channel with integral<br>electro-mechanical hold-open for pull-side fixing                       | 14 |
|  | <b>G-SR-EMR</b><br>Door co-ordinator slide channel with electro-mechanical<br>hold-open and integral smoke detector for pull-side fixing    | 14 |
|  | <b>G-SR/BG</b><br>Door co-ordinator slide channel for push-side fixing  | 18 |
|  | <b>G-SR-EMF/BG</b><br>Door co-ordinator slide channel with integral<br>electro-mechanical hold-open for push-side fixing                    | 18 |
|  | <b>G-SR-EMR/BG</b><br>Door co-ordinator slide channel with electro-mechanical<br>hold-open and integral smoke detector for push-side fixing | 18 |
| Smoke detector                                   | <b>RMZ</b>  | 22 |
|  | <b>RM-N</b>   | 22 |
| Accessories                                      | <b>Single doors</b>   | 24 |
|  | <b>Double doors</b>   | 25 |
| Hold-open systems                                | <b>Regulations/Information</b>  | 27 |
| Range of equipment and Optional accessories      | <b>Single doors</b>   | 28 |
|  | <b>Double doors</b>   | 30 |
| Specification text                               | <b>Single doors</b>   | 32 |
|  | <b>Double doors</b>   | 34 |

# CAM ACTION DOOR CLOSER SYSTEM TS 93

## The perfect project solution for all application needs

The TS 93 cam action door closer system sets new standards in user convenience in project applications. The proven DORMA technology of the heart-shaped cam ensures exceptional ease of opening.

The TS 93 series comprises a modular system which enables just a few door closer models to be combined with a number of different slide channels to meet virtually every conceivable functional requirement. Doors of varying designs can be equipped for a wide range of different applications.

## Plus points...

### ...for the trade

- Clear product allocation ensures use of the right models for the right applications.
- Identical door closer model for single and double doors

### ...for the installer

- The TS 93 system is suitable for all fixing positions.
- Mounting bracket with universal fixing hole pattern for optimal fixing.
- Simple, fast installation.

### ...for the specifier/architect

- High-quality design ensures an ideal solution for all project applications.
- Harmonious appearance thanks to integral smoke detector.
- Available in a wide range of colours and finishes.

### ...for the user

- Easy opening action and fully controlled closing.
- Smoke detector with convenient service and maintenance indicator.
- Adjustable hydraulic functions for easy adaptation to each specific door situation.

| Data and features                                   |                   | TS 93 B/G <sup>1)</sup> |        |
|---|-------------------|-------------------------|--------|
| Variable closing force                              | Spring strength   | EN 2-5                  | EN 5-7 |
| Standard doors <sup>2)</sup>                        | ≤ 1250 mm         | ●                       | –      |
|   | ≤ 1600 mm         | –                       | ●      |
| External doors, outward opening <sup>2)</sup>       | ≤ 1250 mm         | ●                       | –      |
|   | ≤ 1600 mm         | –                       | ●      |
| For fire and smoke check doors <sup>2)</sup>        | ≤ 1250 mm         | ●                       | –      |
|   | ≤ 1600 mm         | –                       | ●      |
| Non-handed  |                   | ●                       | ●      |
| Arm assembly type                                   | Standard          | –                       | –      |
|   | Slide channel     | ●                       | ●      |
| Closing force variable by means of adjustment screw |                   | ●                       | ●      |
| Closing speed adjustable by valve                   |                   | ●                       | ●      |
| Latching speed adjustable                           | at arm            | –                       | –      |
|   | at valve          | ●                       | ●      |
| Backcheck (BC/ÖD)                                   | adjustable        | –                       | –      |
|   | at valve          | ●                       | ●      |
| Delayed action (DC/SV) adjustable at valve          |                   | ●                       | ●      |
| Hold-open   |                   | ○                       | ○      |
| Weight in kg  |                   | 3.5                     | 5.2    |
| Dimensions in mm                                    | Length (L)        | 275                     | 285    |
|   | Overall depth (B) | 53                      | 62     |
|   | Height (H)        | 60                      | 71     |
| Door closer tested to EN 1154                       |                   | ●                       | ●      |
| Hold-open devices tested to EN 1155                 |                   | ●                       | ●      |
| Door co-ordinators tested to EN 1158                |                   | ●                       | ●      |
| CE mark for building products                       |                   | ●                       | ●      |

● yes – no ○ optional

<sup>1)</sup> B = Standard model for pull-side door leaf fixing/push-side transom fixing  
G = Special model for push-side door leaf fixing/pull-side transom fixing.

<sup>2)</sup> For applications involving particularly heavy or wide doors, and doors which have to close against wind resistance, the next highest door closer size should be selected, or the closing force adjusted to a higher setting.

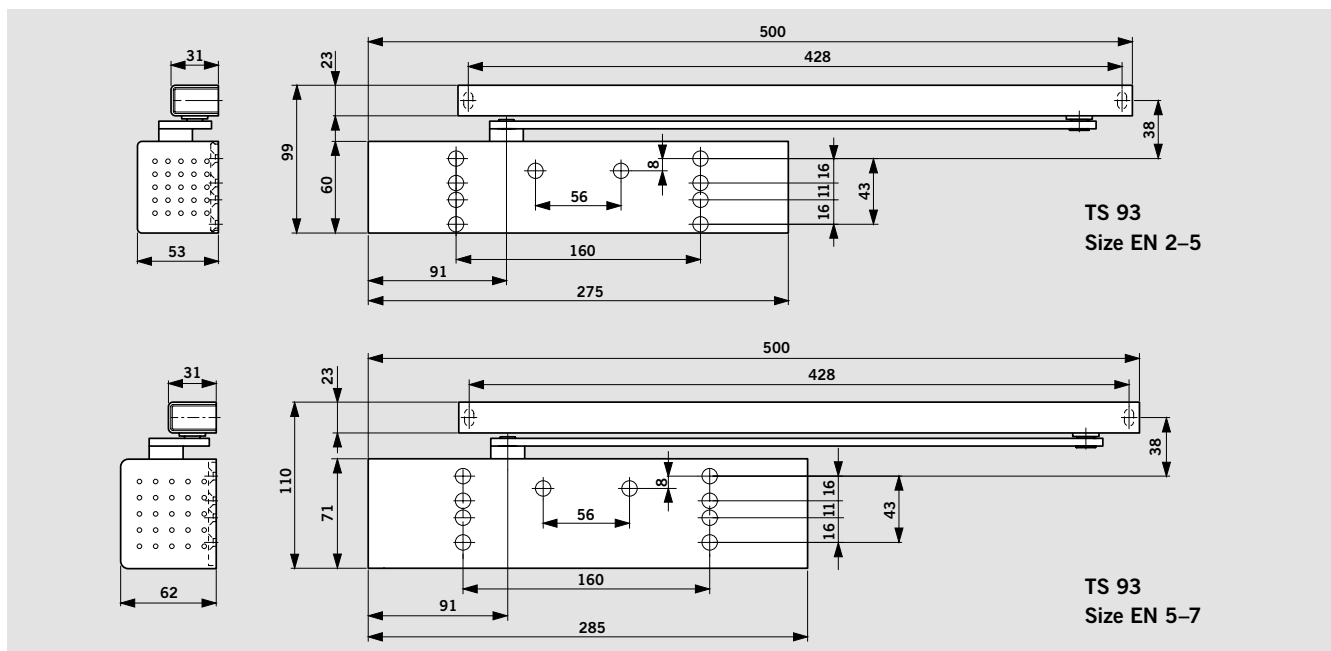

**Standard mounting backplate with universal fixing hole system**

This mounting backplate with its universal hole system, including hole pattern to supplementary sheet 1 of DIN EN 1154 A, ensures ideal fixing whatever the conditions and irrespective of the door type. The fixing hole patterns are the same for both sizes of the TS 93. Additional mounting plates/brackets are no longer required. Alignment dowels on the mounting backplate facilitate location of the closer body.

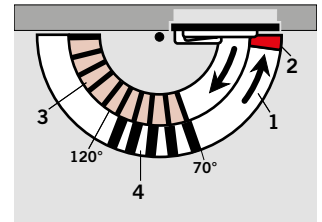
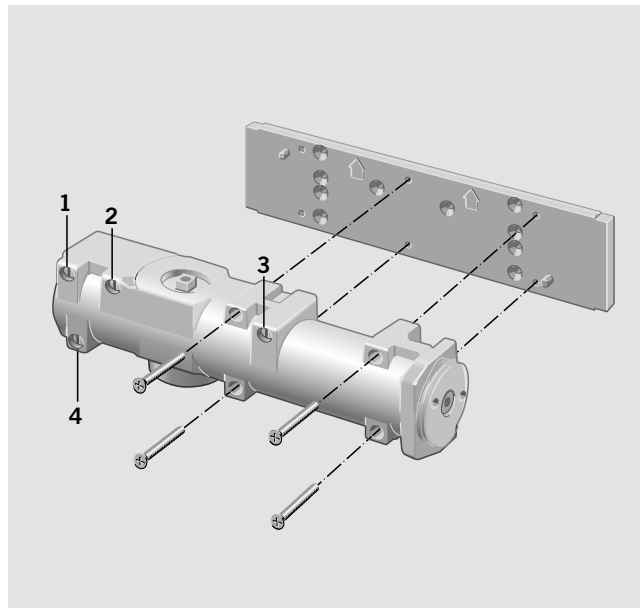

- 1 Fully controlled closing action with adjustable speed
- 2 Adjustable latch speed
- 3 Adjustable backcheck
- 4 Adjustable delayed action

**Backcheck**

The backcheck feature ensures the safe deceleration and restraint of a door which has been flung open or caught by a gust of wind. This effectively reduces the danger of the door and adjacent wall being damaged.

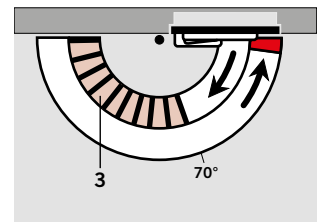

- 3 Adjustable backcheck

**Delayed action**

The delayed action feature retards the closing cycle between 120° and 70° (approximate values for pull-side door leaf fixing). The extra time allowed for passage through the doorway can be essential for people with luggage or bulky items: mothers with prams, personnel with tea trolleys, post trolleys, hospital beds, etc.; and also for disabled people.

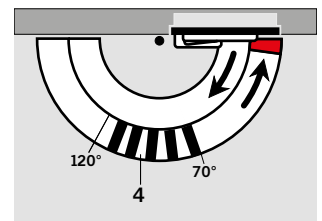
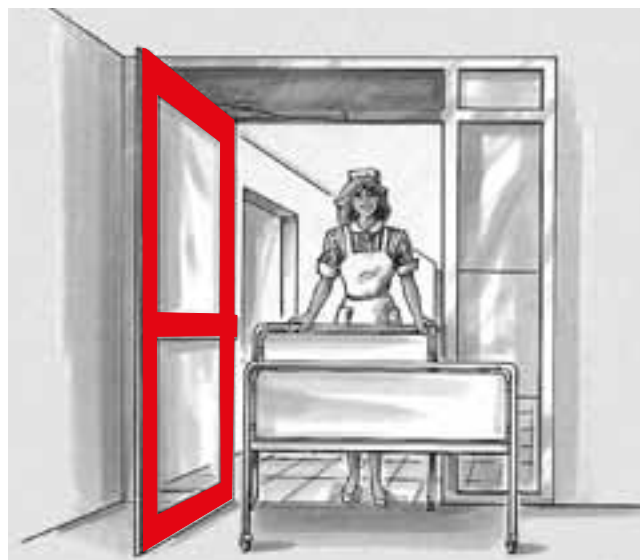

- 4 Adjustable delayed action

## PULL-SIDE DOOR LEAF FIXING

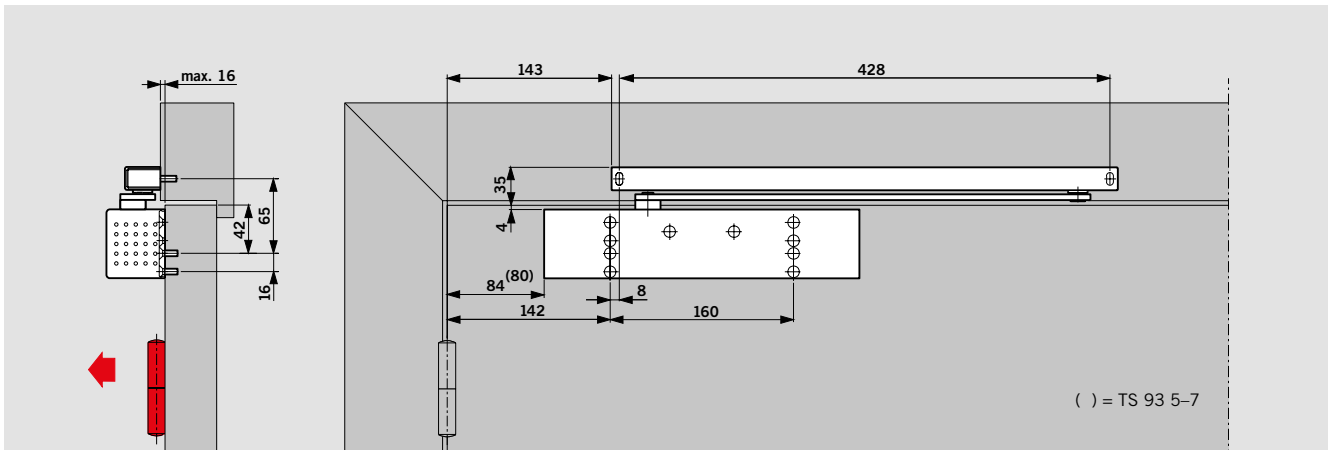

Door leaf fixing (standard arrangement) of the TS 93 B on the pull side. Structural conditions permitting, an opening angle of 180° is

possible with this fixing method. In most cases, a wall recess may have to be provided for the door closer.

### F Approval certification

The DORMA TS 93 B is CERTIFIRE approved (Certificate No. CF 119) for door types ITT 120, MM/IMM 240.



Example: Anticlockwise-closing (ISO 6) door; mirrored arrangements apply to clockwise-closing (ISO 5) doors.

## PUSH-SIDE TRANSOM FIXING

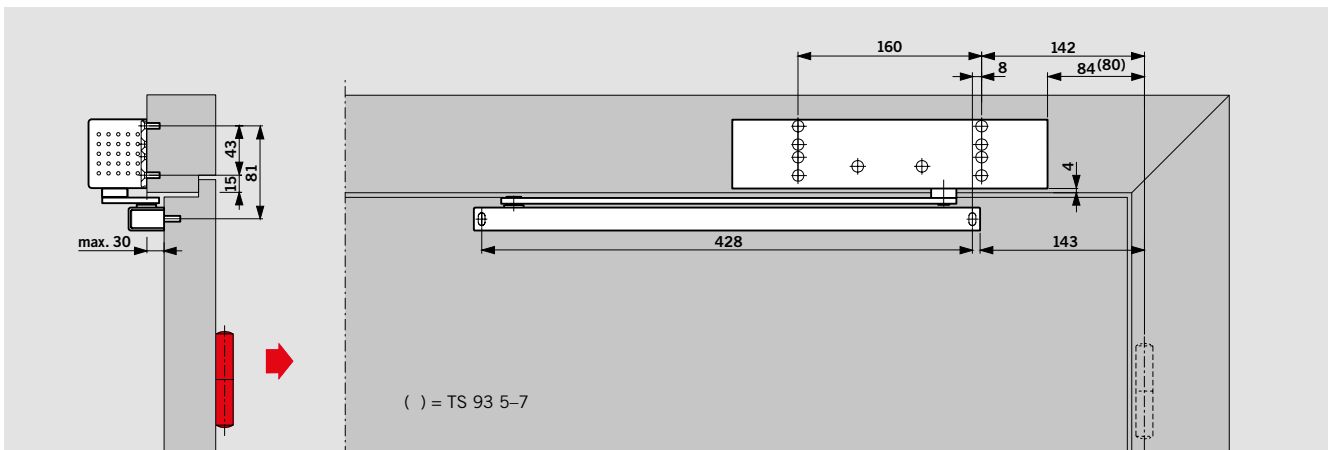

Transom fixing (overhead frame fixing) of the TS 93 B on the push side. Backcheck and delayed action non-operative with this fixing arrangement. The door opening angle is limited to approx. 120° to 145°,

depending on the structural conditions. In order to prevent damage to the wall and door, a door stop should be installed to limit the maximum angle of door opening.

### F Approval certification

The DORMA TS 93 B is CERTIFIRE approved (Certificate No. CF 119) for door types ITT 120, MM/IMM 240.



Example: Anticlockwise-closing (ISO 6) door; mirrored arrangements apply to clockwise-closing (ISO 5) doors.

## PUSH-SIDE DOOR LEAF FIXING

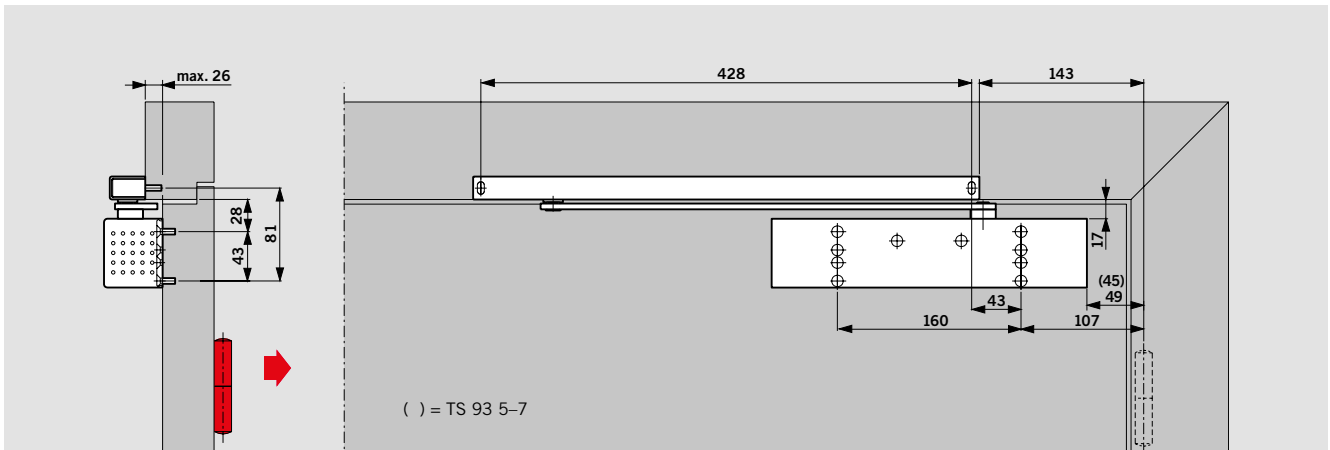

Door leaf fixing (standard installation) of the TS 93 G on the push side.

The door opening angle is limited to approx. 120° to 145°, depending on the structural conditions. In order to prevent damage to the wall and door, a

door stop should be installed to limit the maximum angle of door opening.

**A door stop must be installed for fire and smoke doors.**

### F Approval certification

The DORMA TS 93 G is CERTIFIRE approved (Certificate No. CF 119) for door types ITT 120, MM/IMM 240.



Example: Anticlockwise-closing (ISO 6) door; mirrored arrangements apply to clockwise-closing (ISO 5) doors.

## PULL-SIDE TRANSOM FIXING

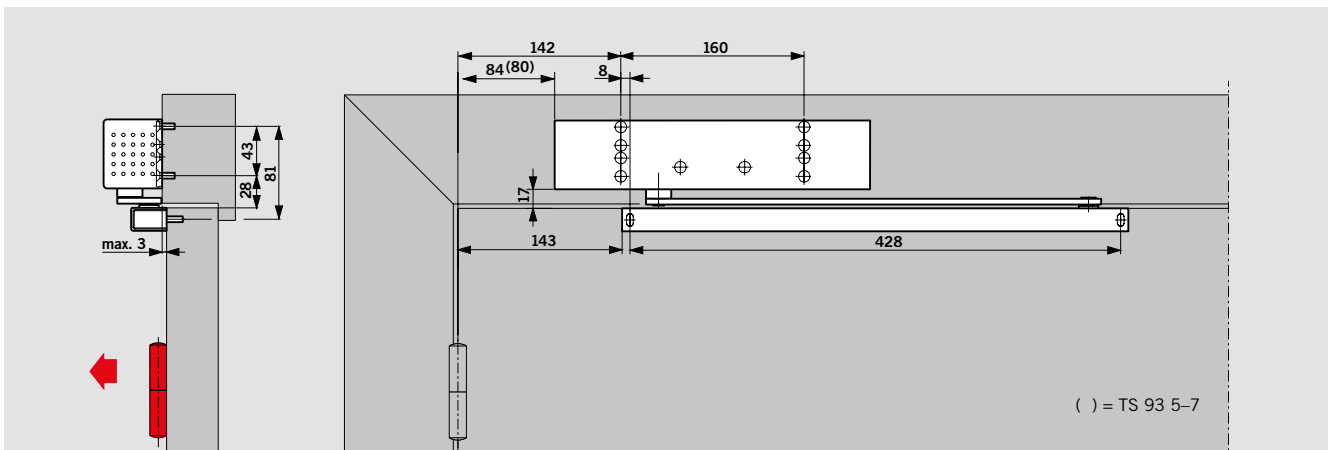

Transom fixing (overhead frame fixing) of the TS 93 G on the pull side. Structural conditions permitting, an opening angle of 180° is possible with this fixing method.

### F Approval certification

The DORMA TS 93 G is CERTIFIRE approved (Certificate No. CF 119) for door types ITT 120, MM/IMM 240.



Example: Anticlockwise-closing (ISO 6) door; mirrored arrangements apply to clockwise-closing (ISO 5) doors

## G-N SLIDE CHANNEL

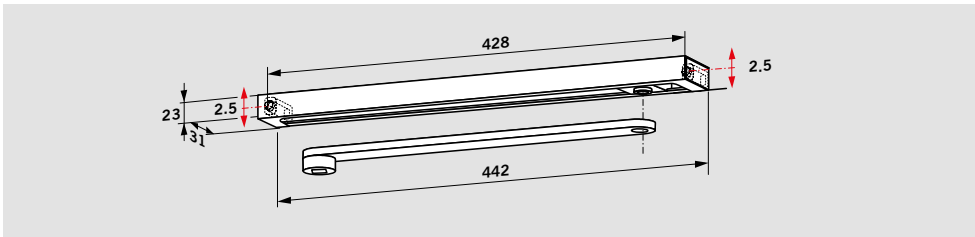

The **G-N** slide channel assembly incorporates the slide arm, slide channel, slide block, fixing adapters, screws and end caps. The G-N slide channel assembly

is non-handed and can be combined with all door closer models. Thanks to oblong holes in the fixing adapters, the slide channel

can be effectively adjusted to variations in the drill hole pattern while keeping the gap between door closer body and slide channel aligned and parallel.

### **F** Approval certification

The DORMA G-N has been successfully type-tested to EN 1154 in conjunction with the TS 93. Certificates are available on request.

## HOLD-OPEN UNIT

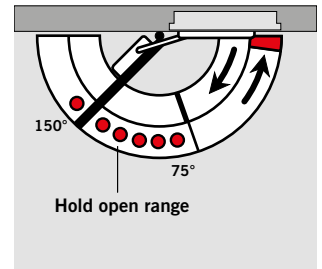
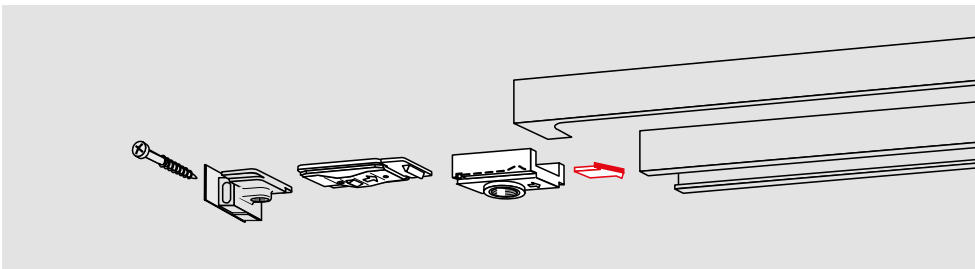

The **RF** hold-open unit enables doors to be securely held without any fall-back at precisely the required position up to an opening angle of approx. 150°. The hold-open function can be easily switched on and off by

the user, and the release force can be adjusted to the door type concerned. The RF mechanism is non-handed and has been specifically designed for retrofitting to the G-N type standard slide channel.

The suitability of the hold-open unit may be limited where the closer unit is fixed to the door leaf on the push side, in combination with outward-opening doors, and also in the case of large, heavy doors.

**Not for fire and smoke doors.**

## CUSHIONED LIMIT STAY

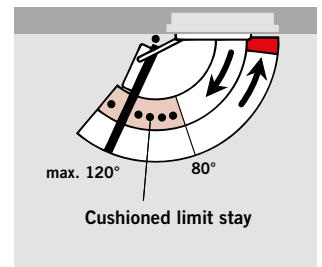
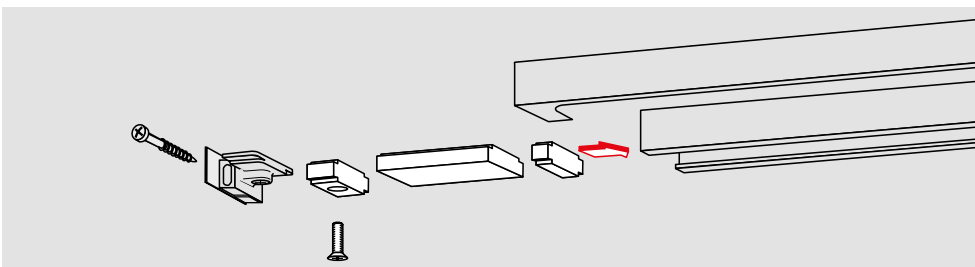

Accessories for the G-N, RF slide channel: **Cushioned limit stay** for retrofitting to the slide channel. Adjustable between 80° and **max. 120°**.

The cushioned limit stay prevents the door from hitting the adYescent wall when opened normally.

**The cushioned limit stay is not a heavy-duty protective device and in many applications cannot substitute for a door stop.**



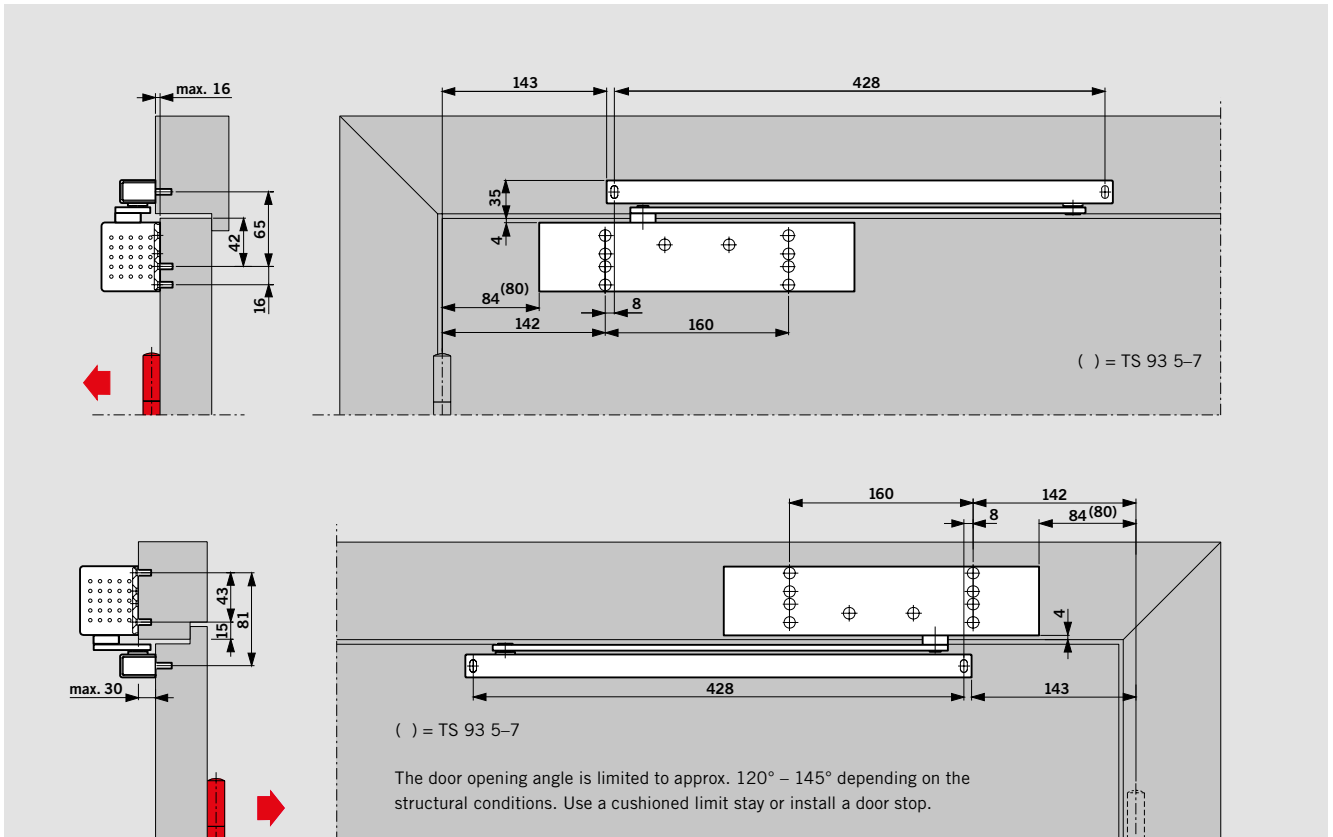

**TS 93 B** door closer with G-N slide channel assembly, door leaf fixing on the pull side and transom fixing on the push side.  
 Examples: Anticlockwise-closing (ISO 6) door; mirrored arrangements apply to clockwise-closing (ISO 5) doors.

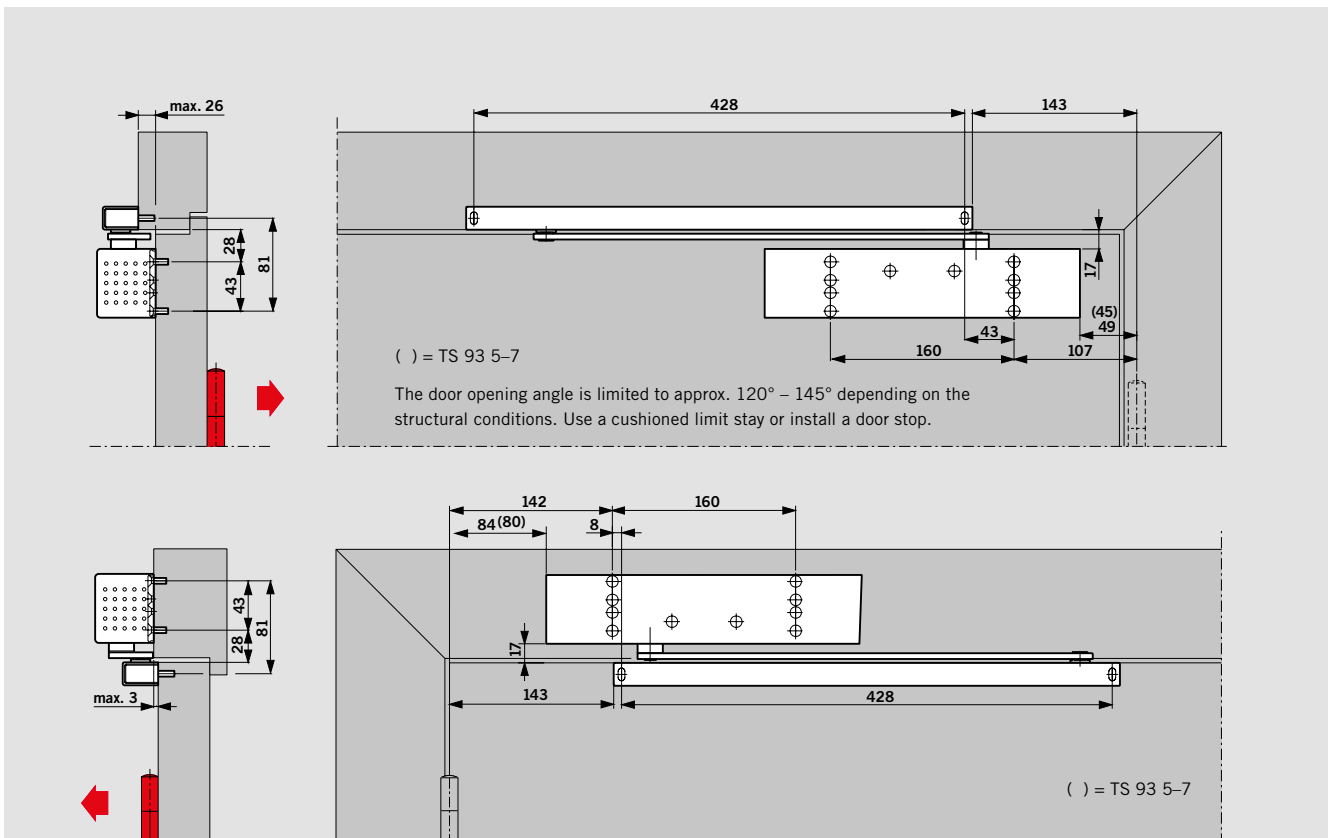

**TS 93 G** door closer with G-N slide channel assembly, door leaf fixing on the push side and transom fixing on the pull side.  
 Examples: Anticlockwise-closing (ISO 6) door; mirrored arrangements apply to clockwise-closing (ISO 5) doors.

# G-EMF SLIDE CHANNEL WITH ELECTRO-MECHANICAL HOLD-OPEN

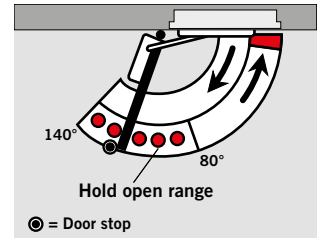
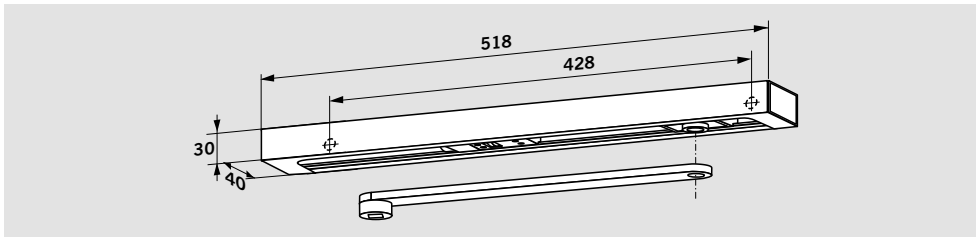

The **G-EMF** slide channel assembly enables the door to be held open securely at a preselected position without fall-back. The hold-open point can be adjusted within an opening angle of approx. 80° and 140°.

**Note**

The active leaf can be opened up to the maximum selected hold-open point (door stop to be positioned accordingly).

In the event of an alarm or a fault in the power supply, the hold-open is released and the door is closed by the door closer. The release is triggered by a signal from external smoke detectors (e.g. DORMA RMZ or DORMA RM). The release force for the hold-open mechanism can be adjusted without tools

and is rated to ensure that the door can also be easily released manually. The G-EMF slide channel assembly comprises the slide arm, slide channel, slide block, electro-mechanical hold-open unit, cover, fixing screws and end caps. The G-EMF is transom-fixed and non-handed. In the case of particularly large

and heavy doors (over 1250 mm), or doors in which the hold-open point required exceeds 140°, we recommend that DORMA EM hold-open magnets in conjunction with the DORMA RMZ central smoke detector be employed instead of the electro-mechanical hold-open unit.

| Technical data            |                |
|---------------------------|----------------|
| Operating voltage         | 24 V DC, ± 15% |
| Power input               | 1.4 W          |
| Rated for continuous duty | 100% ED        |
| Release force             | adjustable     |

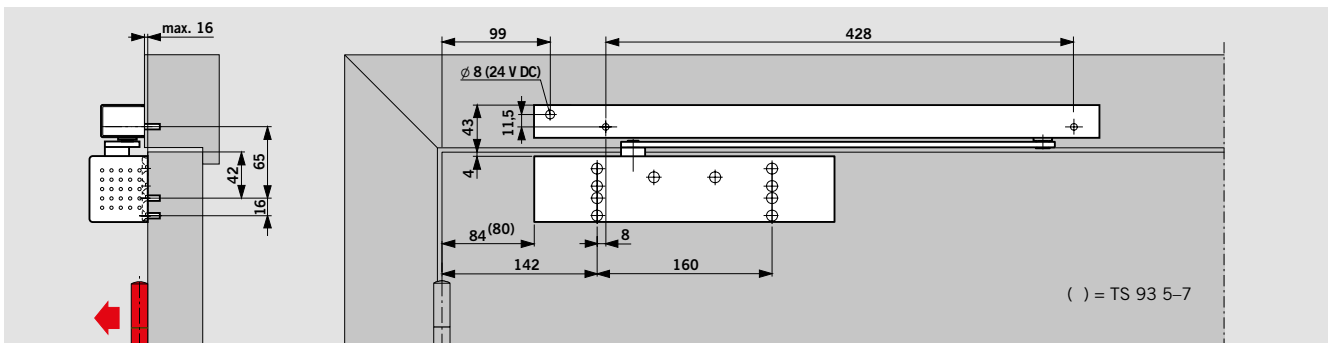

**TS 93 B** closer with G-EMF slide channel assembly, pull-side fixing  
 Example: Anticlockwise-closing (ISO 6) door; mirrored arrangements apply to clockwise-closing (ISO 5) doors.

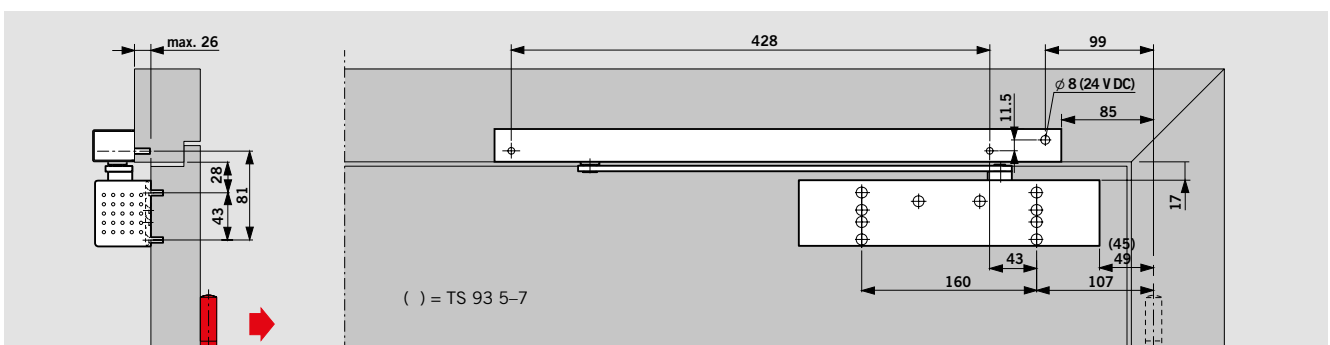

**TS 93 G** closer with G-EMF slide channel assembly, push-side fixing  
 Example: Anticlockwise-closing (ISO 6) door; mirrored arrangements apply to clockwise-closing (ISO 5) doors.

**F Approval certification**

The TS 93 EMF has been successfully type-tested to EN 1155, Electrically Powered Hold-Open Devices. Certificates are available on request.

**Regulations/Information**

The use of hold-open devices may be subject to certain conditions – see page 27.

**Example application**

Hold-open system on a fire and smoke door, comprising: TS 93 B door closer, G-EMF slide channel assembly, RMZ (smoke sensor, release switching unit and stabilised power pack for 24 vDC) as frame-mounted smoke detector, plus one RM-N smoke detector on both sides of the door. (See also page 22.)

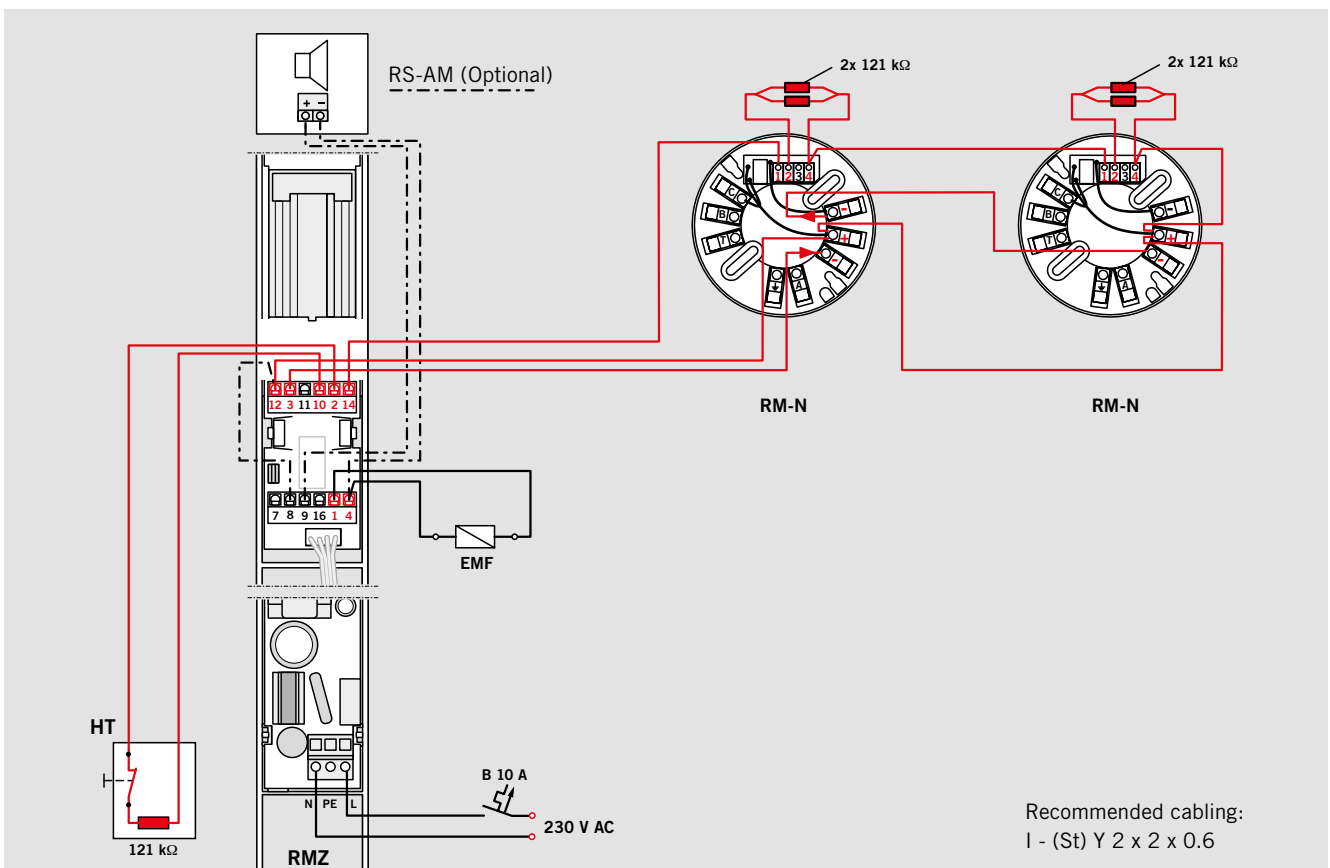
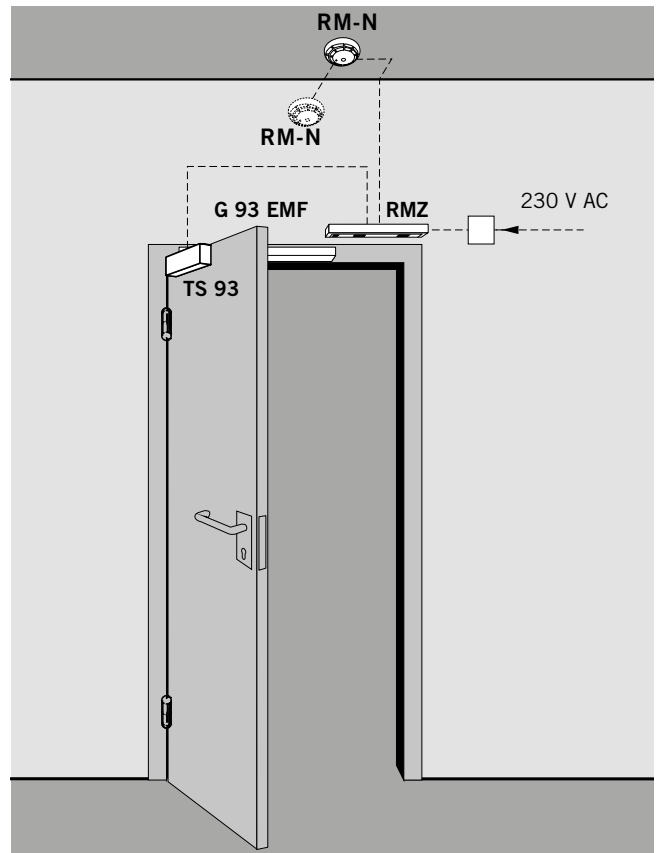

# G-EMR SLIDE CHANNEL ELECTRO-MECHANICAL HOLD-OPEN AND INTEGRAL SMOKE DETECTOR

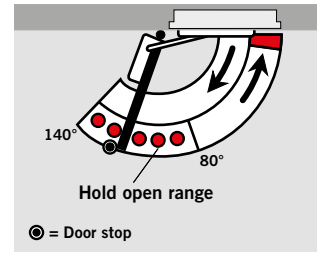
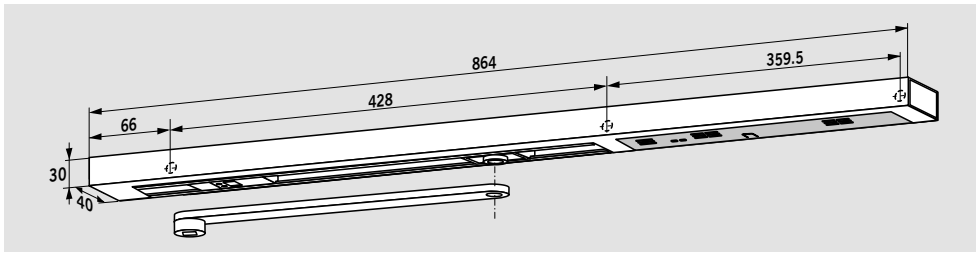

The G-EMR slide channel assembly enables fire and smoke doors to be held open securely at precisely the angle required, and monitored and controlled completely independently of other systems. The hold-open point can be adjusted to opening angles between approx. 80° and 140°.

**Note**

The active leaf can be opened up to the maximum selected hold-open point (door stop to be positioned accordingly).

In the event of an alarm or a fault in the power supply, the

hold-open is released and the door is closed by the door closer. The release force for the hold-open mechanism can be adjusted without tools and is rated to ensure that the door can also be easily released manually. The G-EMR slide channel assembly comprises the arm, slide channel, slide block, electro-mechanical hold-open unit, smoke detector, power pack, cover, fixings and end caps. It is non-handed, enabling use with both RH/ISO 5 and LH/ISO 6 doors. A floating (volt-free) alarm contact and connections for further detectors and external manual release devices are

provided. The G-SR-EMR DCW® slide channel assembly is also available without a power pack for integration in building management and control systems via a DCW® bus and the DORMA TMS door management system. In the case of particularly large and heavy doors (over 1250 mm),

or doors in which the hold-open point required exceeds 140°, we recommend that DORMA EM hold-open magnets be employed instead of the electro-mechanical hold-open unit, in conjunction with the DORMA RMZ-K/S frame-mounted smoke detector.

**Technical data**

|                              |                |
|------------------------------|----------------|
| Power supply                 | 230 V AC ± 10% |
| Operating voltage (internal) | 24 V DC        |
| Max. output rating           | 9.8 W          |
| Power input EMF              | 1.4 W          |
| Rated for continuous duty    | 100% ED        |
| Release force                | adjustable     |

detailed data see page 22

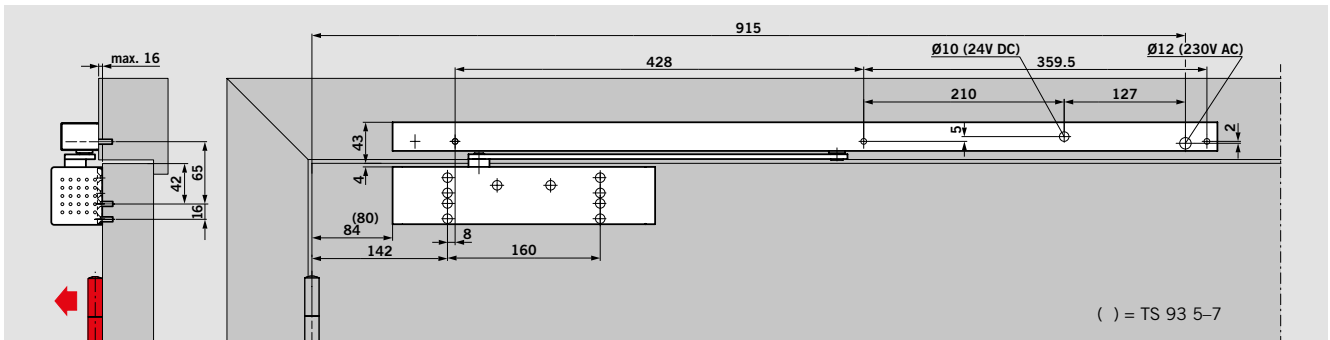

**TS 93 B** closer with G-EMR slide channel assembly, pull-side fixing  
 Example: Anticlockwise-closing (ISO 6) door; mirrored arrangements apply to clockwise-closing (ISO 5) doors.

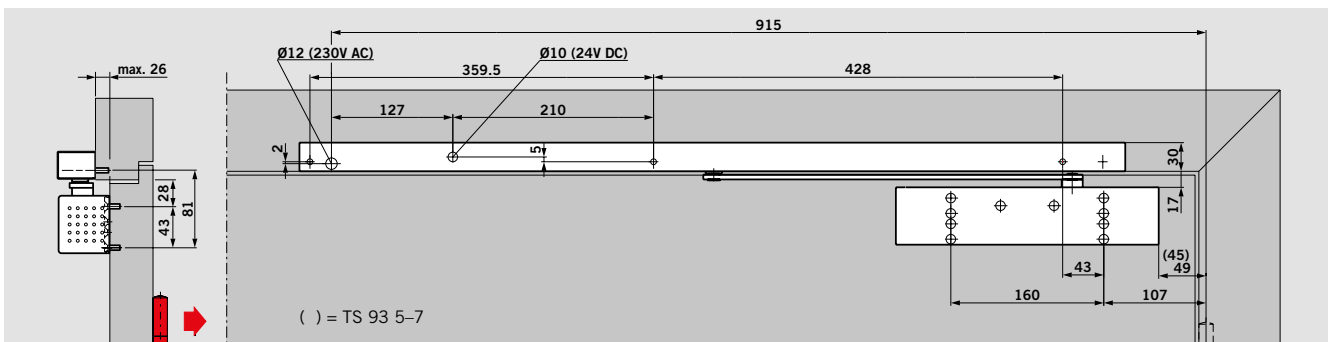

**TS 93 G** door closer with G-EMR slide channel assembly, push-side fixing  
 Example: Anticlockwise-closing (ISO 6) door; mirrored arrangements apply to clockwise-closing (ISO 5) doors.

**F Approval certification**

The TS 93 EMR has been successfully type-tested to EN 1155, Electrically Powered Hold-Open Devices. Certificates are available on request.

**Regulations/Information**

The use of hold-open devices may be subject to certain conditions – see page 27.

**Example application**

Hold-open system on a fire and smoke door, comprising: TS 93 B door closer, G-EMR slide channel assembly, plus one RM smoke detector on both sides of the door. (See also page 22.)

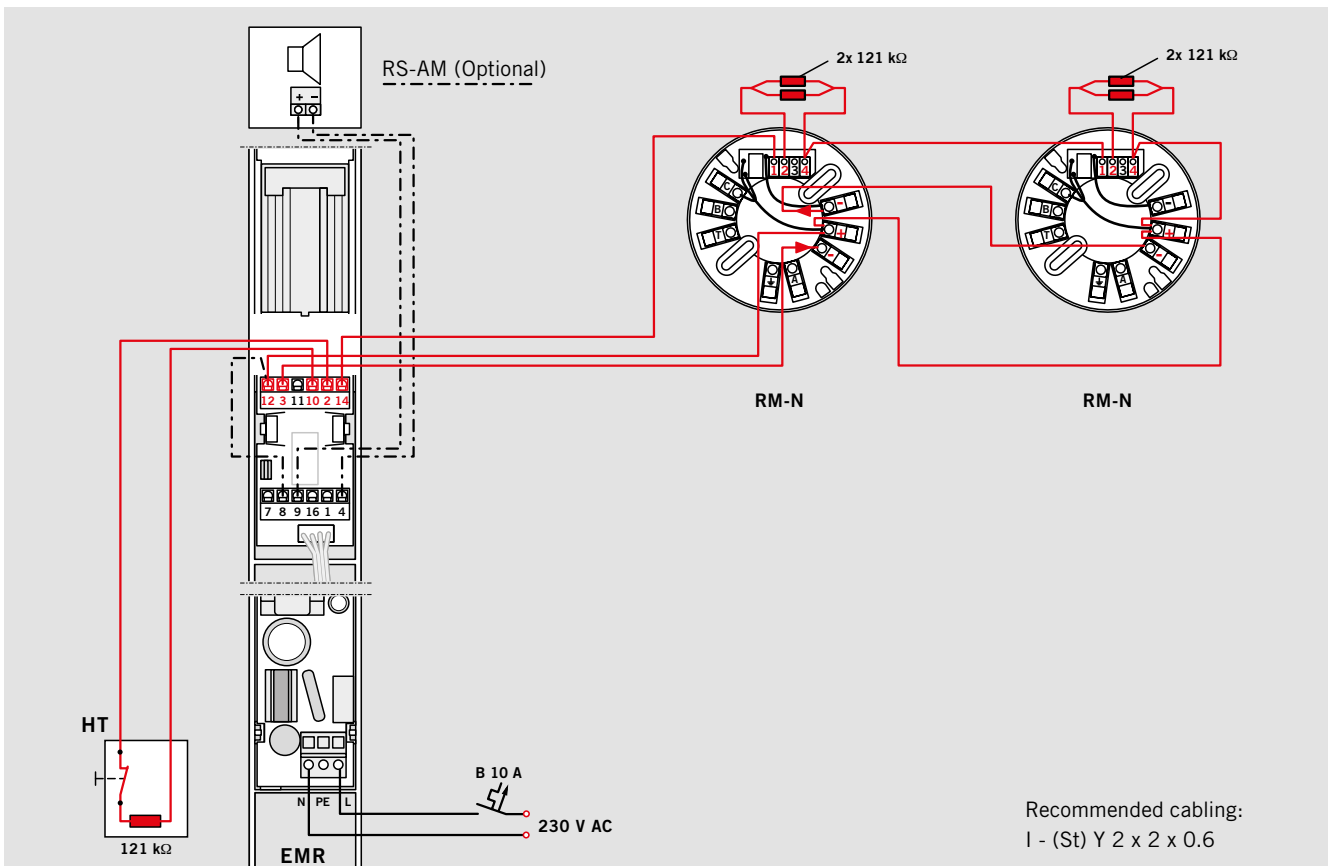
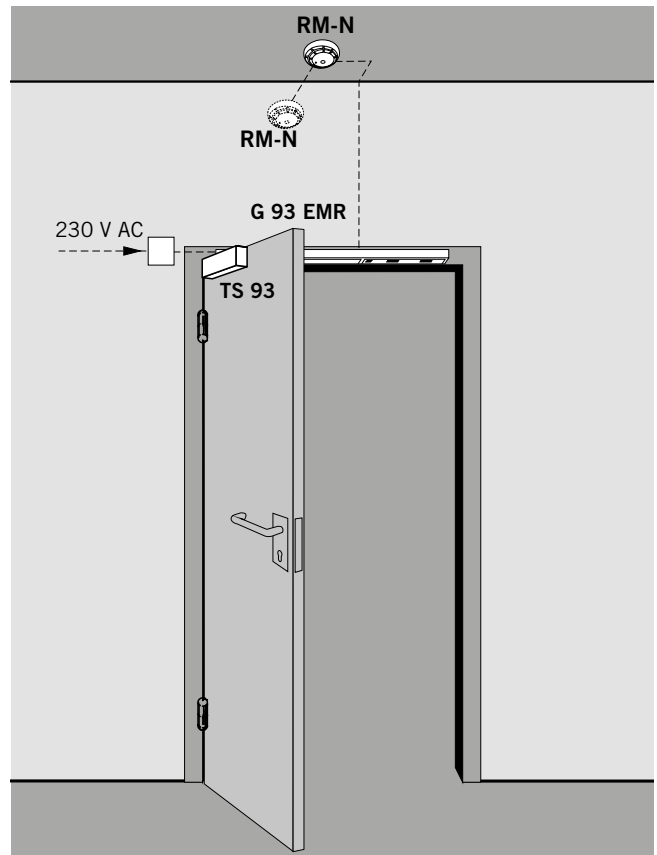

## G-SR DOOR CO-ORDINATOR SLIDE CHANNEL PULL SIDE FIXING

The G-SR slide channel with integral door co-ordinator featuring a push rod clamping system for **double doors**, ensures that the active leaf always closes after the inactive leaf. As this system operates independently of the door closer hydraulics, it offers maximum safety and reliability (doors prevented from “creeping closed”).

An overload release protects both the door co-ordinator and the door set from damage. The G-SR door co-ordinator is non-handed and suitable for combination with TS 93 B door closers.

### **F** Approval certification

The TS 93 G-SR has been successfully type-tested to EN 1158, Door Co-ordinator Devices. Certificates are available on request.

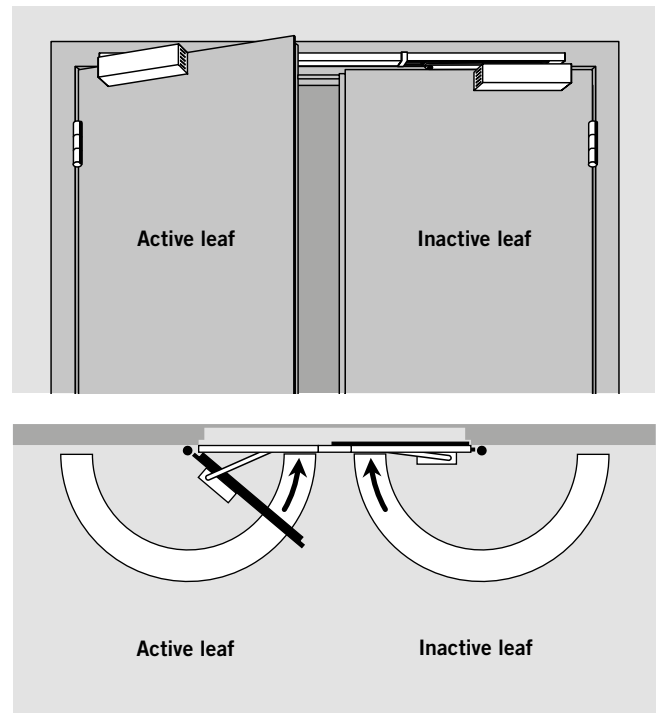

## G-SR-EMF WITH ELECTRO-MECHANICAL HOLD-OPEN G-SR-EMR WITH INTEGRAL SMOKE DETECTOR

These door co-ordinators not only ensure the correct closing sequence of double doors, but also allow the door leaves to be individually held open. In the event of an alarm or power failure, the hold-open is released and the door is closed by the door closer.

The release action is triggered by a signal from the smoke detector integrated in the G-SR-EMR door co-ordinator. The G-SR-EMR DCW® door co-ordinator model is also available without a power pack for integration in building management and control systems via a DCW® bus and the DORMA TMS door management system.

The pull-off force for the hold-open mechanism can be adjusted without tools and is rated to ensure that the door can also be easily released

manually. G-SR-EMF and G-SR-EMR door co-ordinators are non-handed and suitable for combination with TS 93 B door closers. In the case of doors in which the hold-open point required exceeds 130°, we recommend that DORMA EM hold-open magnets be applied instead of the electro-mechanical hold-open unit.

### **Regulations/Information**

The use of hold-open devices may be subject to certain conditions – see page 27.

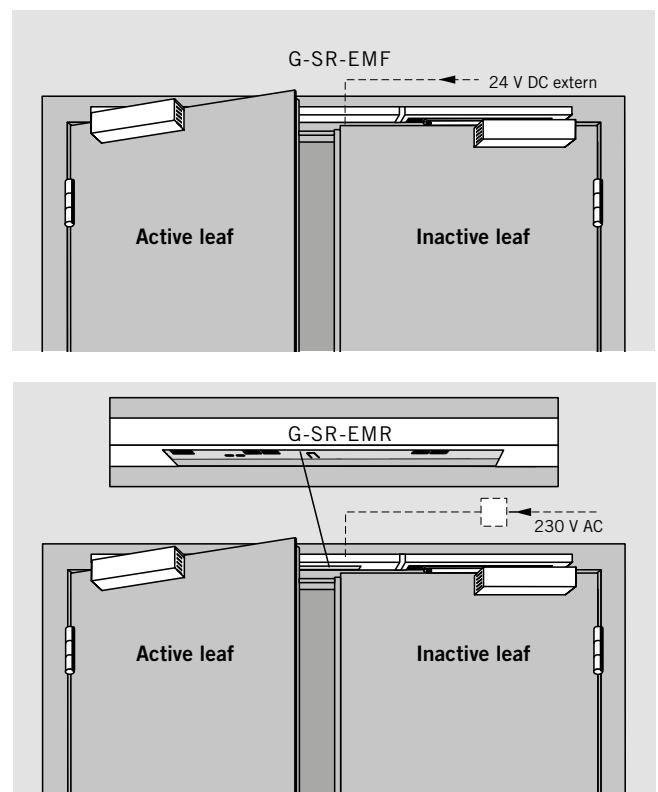

**G-SR-EMF 1**

This door co-ordinator contains just one hold-open mechanism, located in the inactive leaf slide channel, for holding open both door leaves. The single-point hold-open position is adjustable between approx. 80° and 130°.

**Note**

The active leaf can be opened up to the maximum selected hold-open point (door stop to be positioned accordingly). The active leaf can be held open by the door co-ordinator at any angle up to max. 150°.

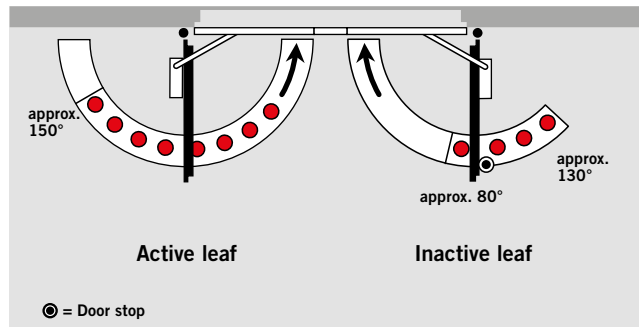

**G-SR-EMR 1**

This door co-ordinator includes an integral smoke detector. A floating (volt-free) alarm contact and connections for further detectors and external manual release devices are also provided. Technical data for smoke detectors: see page 22.

**G-SR-EMF 2**

With this door co-ordinator, the active leaf can be held open independently of the inactive leaf. The hold-open points for each leaf lie between approx. 80° and 130°.

**Note**

The active leaf can be opened up to the maximum selected hold-open point (door stop to be positioned accordingly).

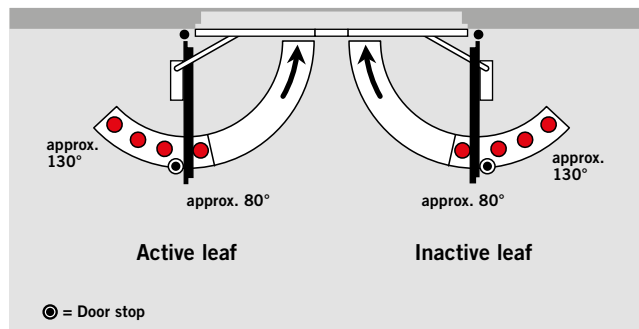

**G-SR-EMR 2**

This door co-ordinator includes an integral smoke detector. A floating (volt-free) alarm contact and connections for further detectors and external manual release devices are also provided. Technical data for smoke detectors: see page 22.

**G-SR-EMF 1G:**

This door co-ordinator enables the active leaf to be held open independently in special door sets involving, for example, fixed side screens, narrow inactive leaves („penny farthing“ doors), etc. The hold-open point lies between approx. 80° and 130°.

**Note**

The active leaf can be opened up to the maximum selected hold-open point (door stop to be positioned accordingly).

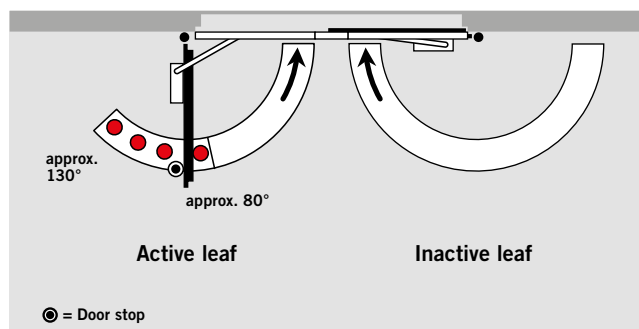

**G-SR-EMR 1G:**

This door co-ordinator includes an integral smoke detector. A floating (volt-free) alarm contact and connections for further detectors and external manual release devices are also provided. Technical data for smoke detectors: see page 22.

**F Approval certification**

The TS 93 G-SR-EMF 1, EMF 2 and EMF 1G have been successfully type-tested to EN 1155, Electrically Powered Hold-Open Devices. Certificates are available on request.

| Technical data            |       |                |
|---------------------------|-------|----------------|
| Power supply              | EMR   | 230 V AC ± 10% |
| Max. output rating        | EMR   | 9.8 W          |
| Operating voltage         | EMF   | 24 V DC, ± 15% |
| Power input               | EMF 1 | 1.4 W          |
|                           | EMF 2 | 2.8 W          |
| Rated for continuous duty |       | 100% ED        |
| Release force             |       | adjustable     |

**F Approval certification**

The TS 93 G-SR-EMR 1, EMR 2 and EMR 1G have been successfully type-tested to EN 1155, Electrically Powered Hold-Open Devices. Certificates are available on request.

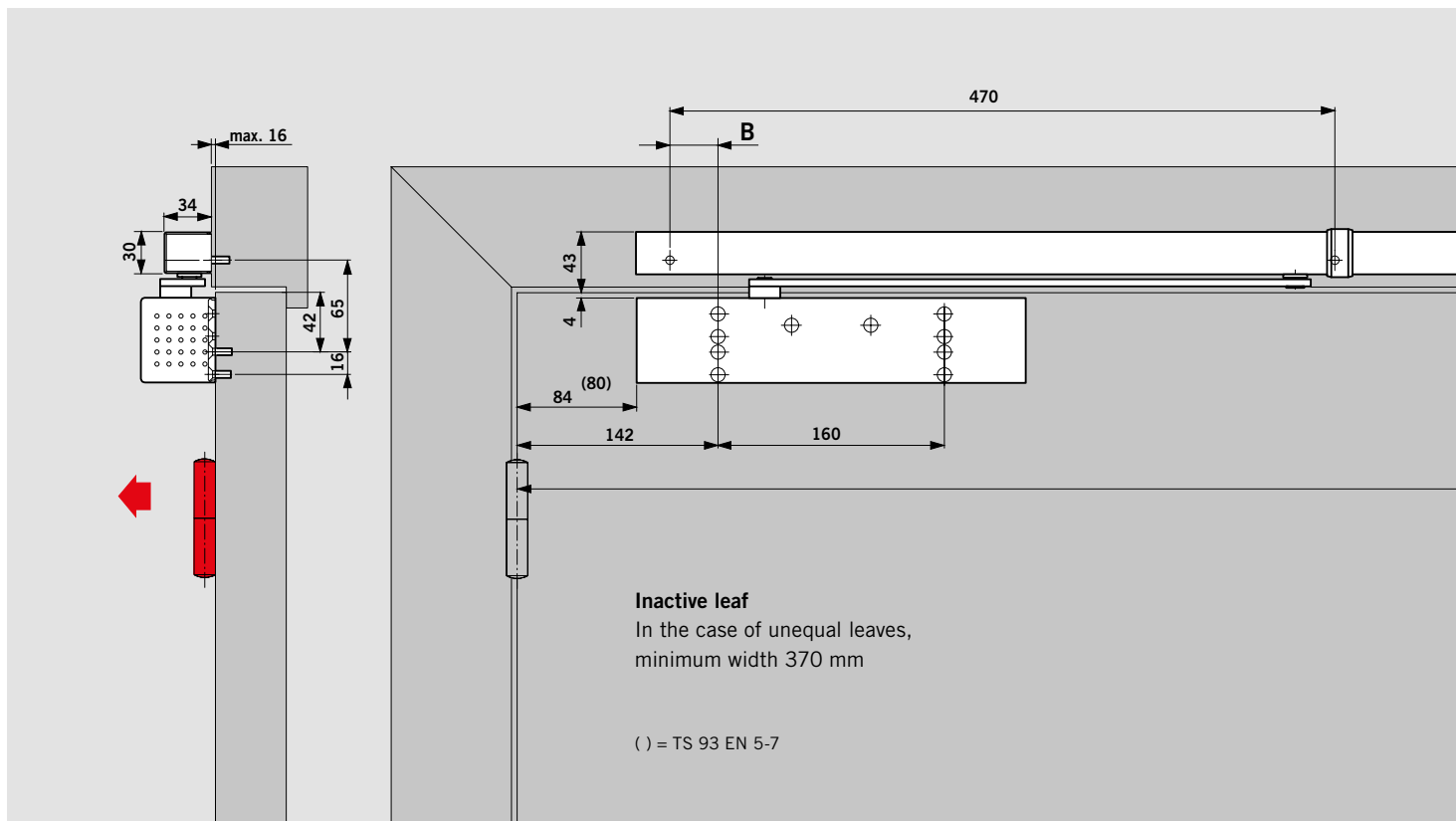

Door co-ordinator **TS 93 B** with electro-mechanical hold-open G-SR/G-SR-EMF, pull side fixing

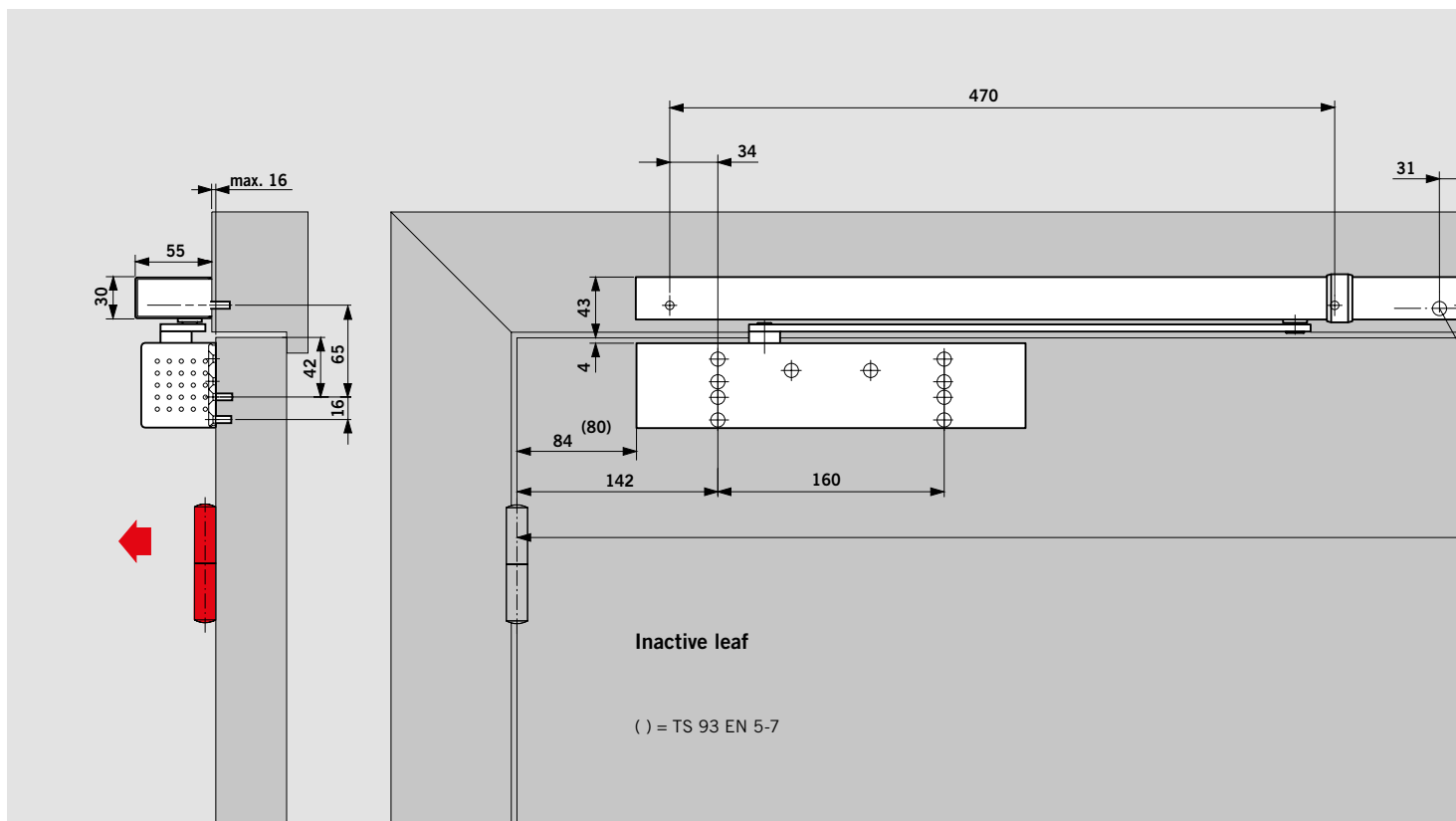

Door co-ordinator **TS 93 B** with integral smoke detector G-SR-EMR, pull side fixing



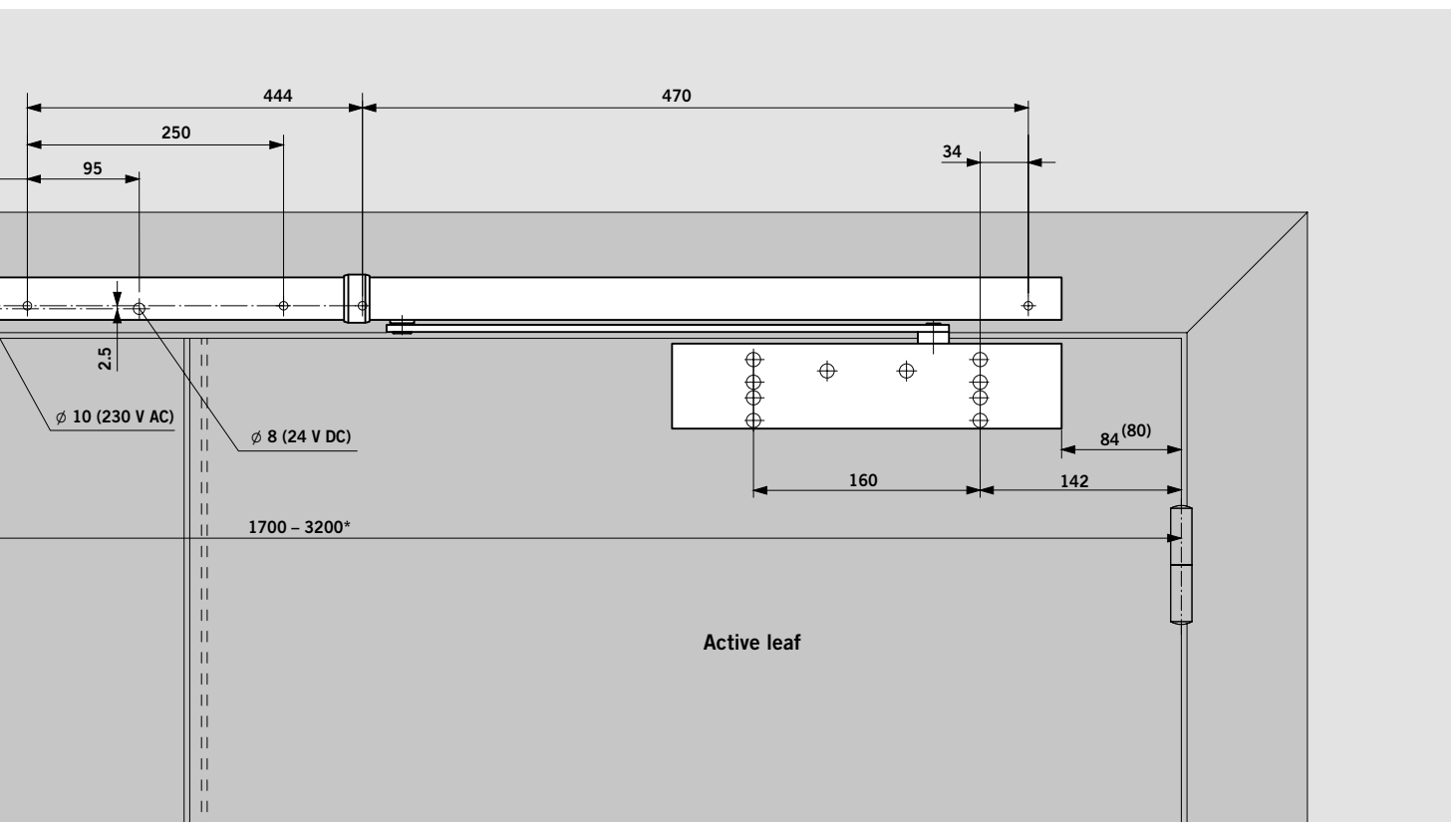
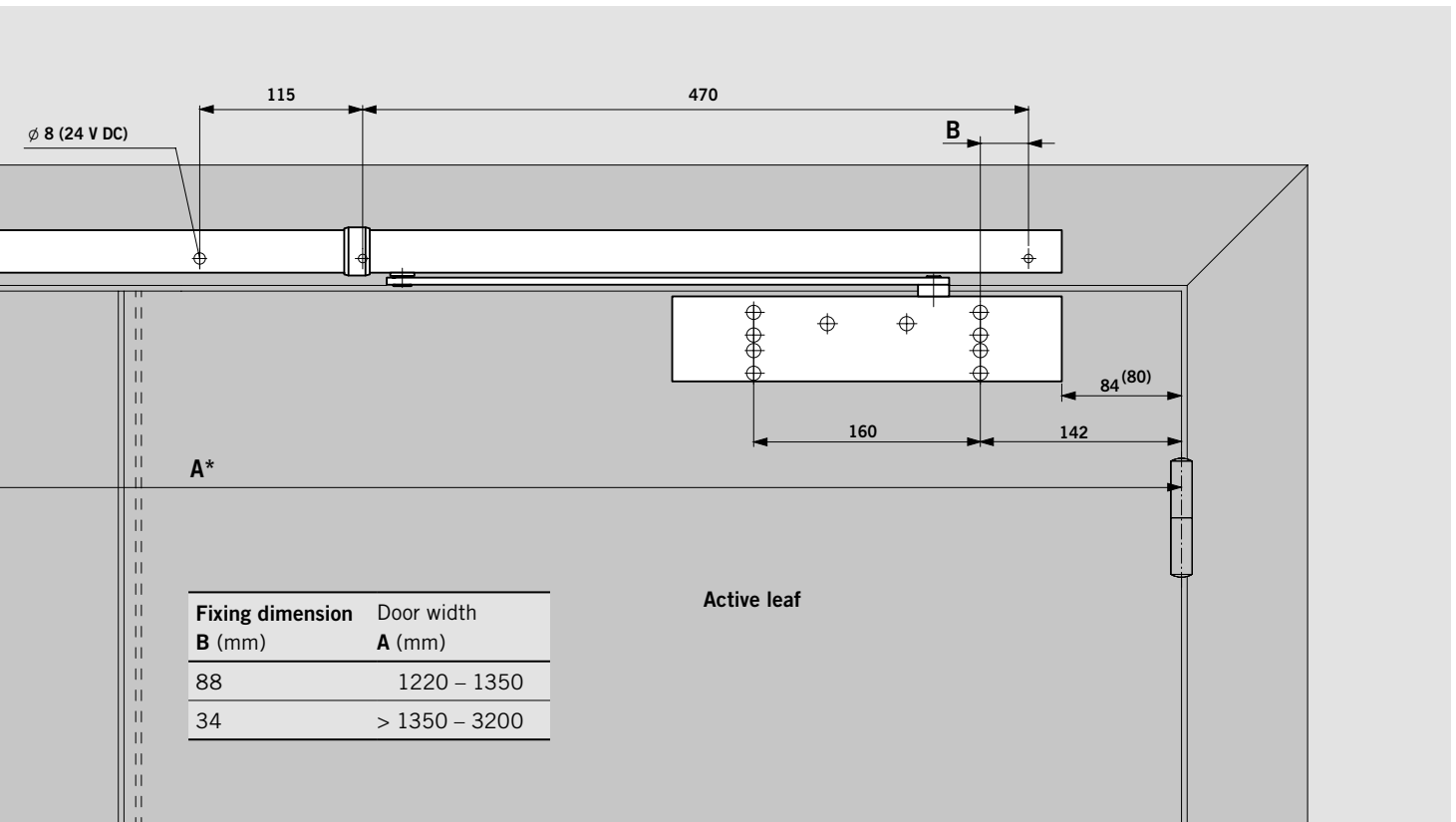

\* In the case of particularly large and heavy doors (over 2500 mm), we recommend that DORMA EM hold-open magnets be employed instead of the electro-mechanical hold-open unit.

## G-SR/BG SLIDE CHANNEL DOOR CO-ORDINATORS PUSH SIDE FIXING

The G-SR/BG push-side slide channel with integral door co-ordinator, featuring a push rod clamping system for **double doors**, ensures that the active leaf always closes after the inactive leaf. As this system operates independently of the door closer hydraulics, it offers maximum safety and reliability (doors prevented from “creeping closed”). An overload release protects both the door co-ordinator and the door set from damage. The DORMA G-SR/BG door coordinator is non-handed and suitable for combination with DORMA TS 93 G door closers.

**Note**  
Max. opening angle 120° (door stop to be positioned accordingly).  
Not suitable for emergency exit doors which are opened at the inactive leaf.

### **F** Approval certification

The TS 93 G-SR/BG has been successfully type-tested to EN 1158, Door Co-ordinator Devices. Certificates are available on request.

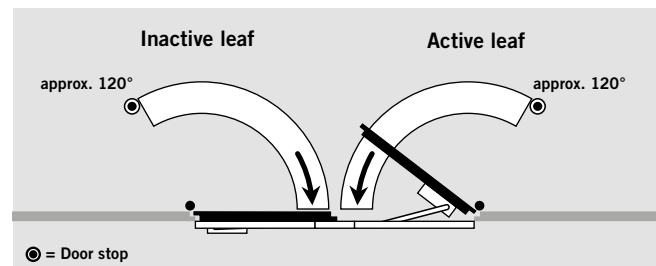
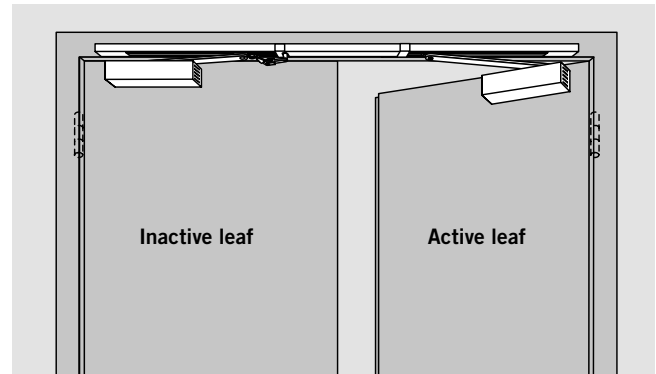

## G-SR-EMF/BG WITH ELECTRO-MECHANICAL HOLD-OPEN G-SR-EMR/BG WITH INTEGRAL SMOKE DETECTOR

These push-side door co-ordinators not only ensure the correct closing sequence of double doors, but also allow the door leaves to be individually held open. In the event of an alarm or power failure, the hold-open is released and the door is closed by the door closer. The release is triggered by a signal from the smoke detector integrated in the G-SR-EMR/BG door co-ordinator. The G-SR-EMR DCW®/BG door co-ordinator model is also available without a power pack for integration in building management and control systems via a DCW® bus and the DORMA TMS door management system. The pull-off force for the hold-open mechanism can be adjusted without tools and is rated to ensure that the door

can also be easily released manually. The G-SR-EMF/BG and G-SR-EMR/BG door co-ordinators are non-handed and suitable for combination with TS 93 G door closers. Not suitable for emergency exit doors which are opened at the inactive leaf.

**Regulations/Information**  
The use of hold-open devices may be subject to certain conditions – see page 27.

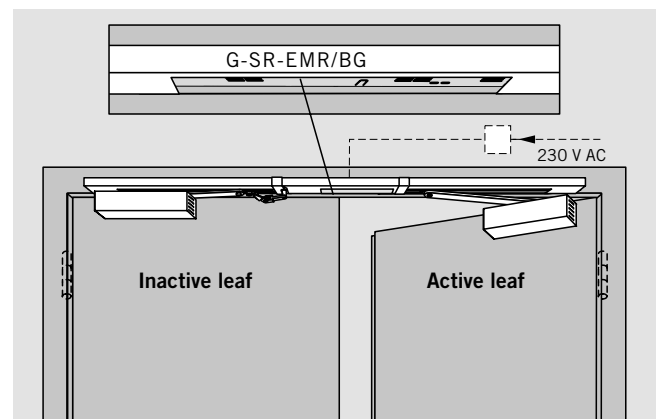
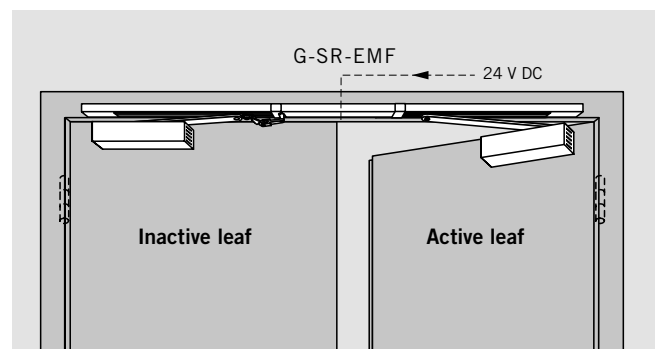

**G-SR-EMF 2/BG**

With this door co-ordinator, the active leaf can be held open independently of the inactive leaf. The hold-open points for each leaf lie between approx. 80° and 120°.

**Note**

The active leaf can be opened up to the maximum selected hold-open point (door stop to be positioned accordingly).

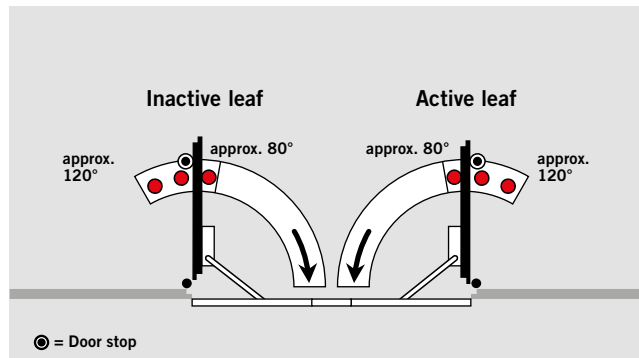

**G-SR-EMR 2/BG**

This push-side door co-ordinator includes an integral smoke detector.

A floating (volt-free) alarm contact and connections for further detectors and external manual release devices are also provided.

Technical data for smoke detectors: see page 22.

**F Approval certification**

The TS 93 G-SR-EMF 2/BG have been successfully type-tested to EN 1155, Electrically Powered Hold-Open Devices. Certificates are available on request.

**Technical data**

|                           |                |
|---------------------------|----------------|
| Power supply EMR          | 230 V AC ± 10% |
| Max. output rating EMR    | 9.8 W          |
| Operating voltage EMF     | 24 V DC, ± 15% |
| Power input EMF 2         | 2.8 W          |
| Rated for continuous duty | 100% ED        |
| Release force             | adjustable     |

**F Approval certification**

The TS 93 G-SR-EMR 2/BG has been approved by the German Institute for Building Technology, Berlin, for use as a hold-open unit. Acceptance inspection of the system is mandatory.

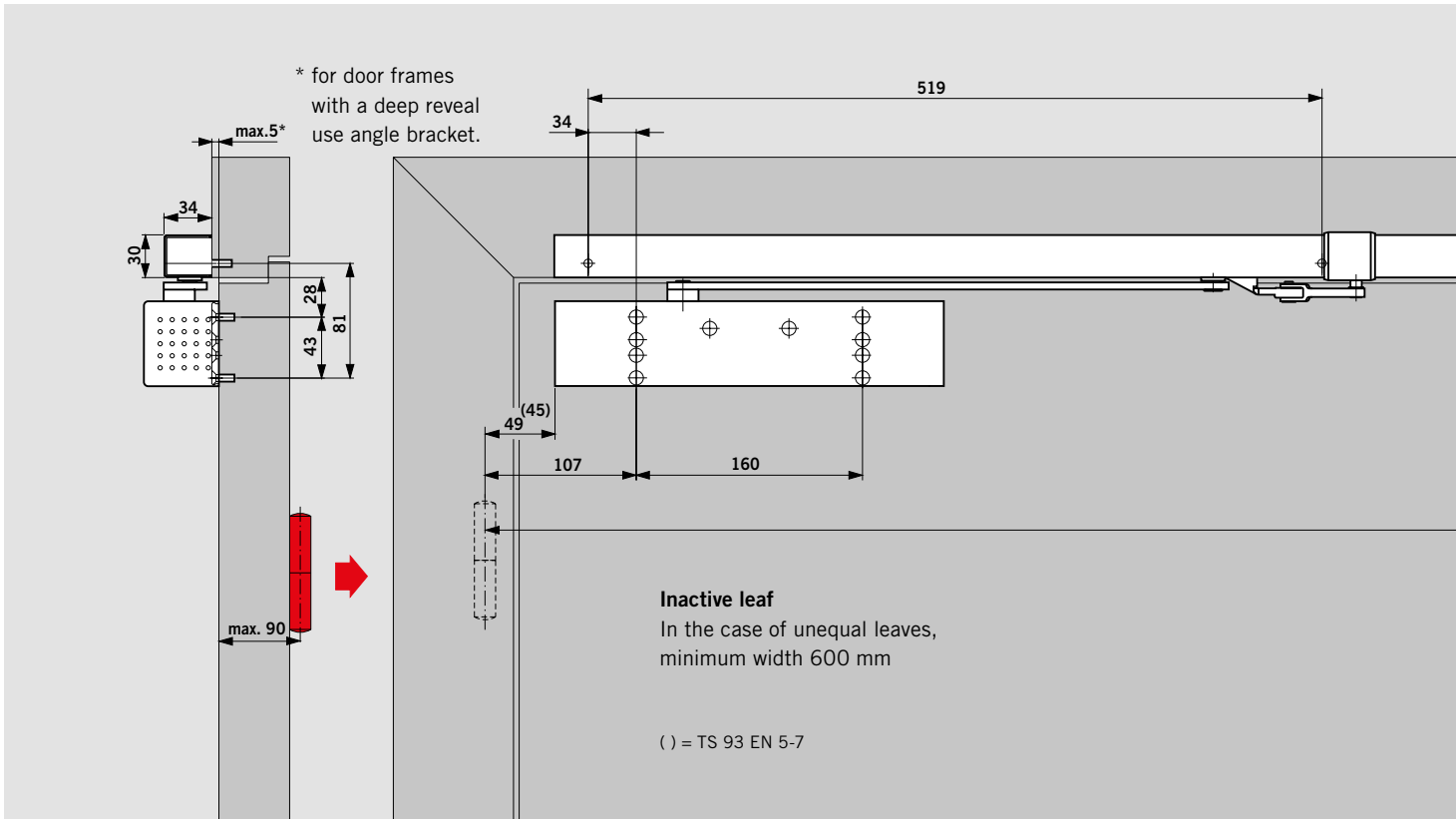

Door co-ordinator **TS 93 G** with electro-mechanical hold-open G-SR/BG / G-SR-EMF/BG, push side fixing

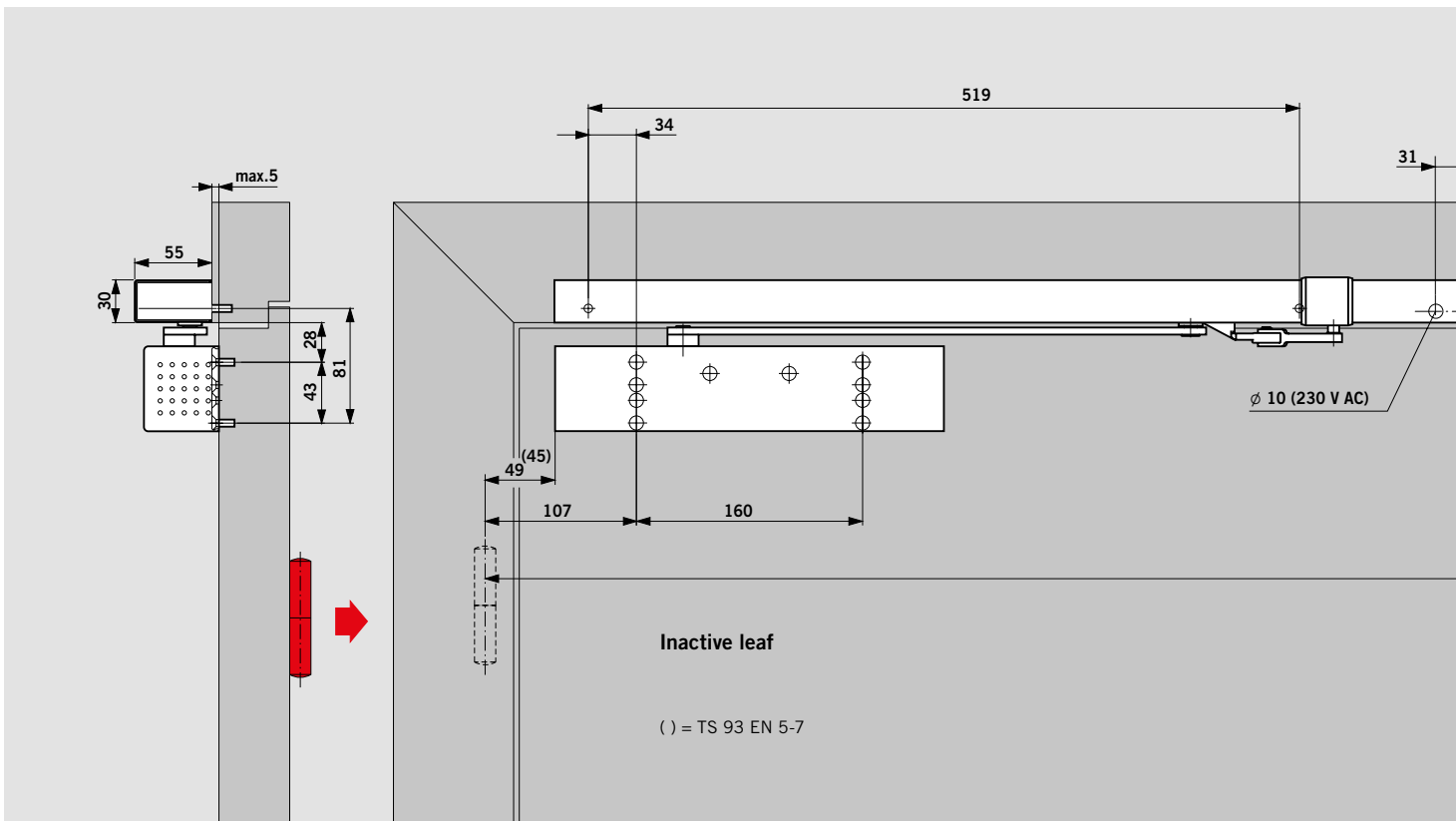

Door co-ordinator **TS 93 G** with integral smoke detector G-SR-EMR/BG, push side fixing

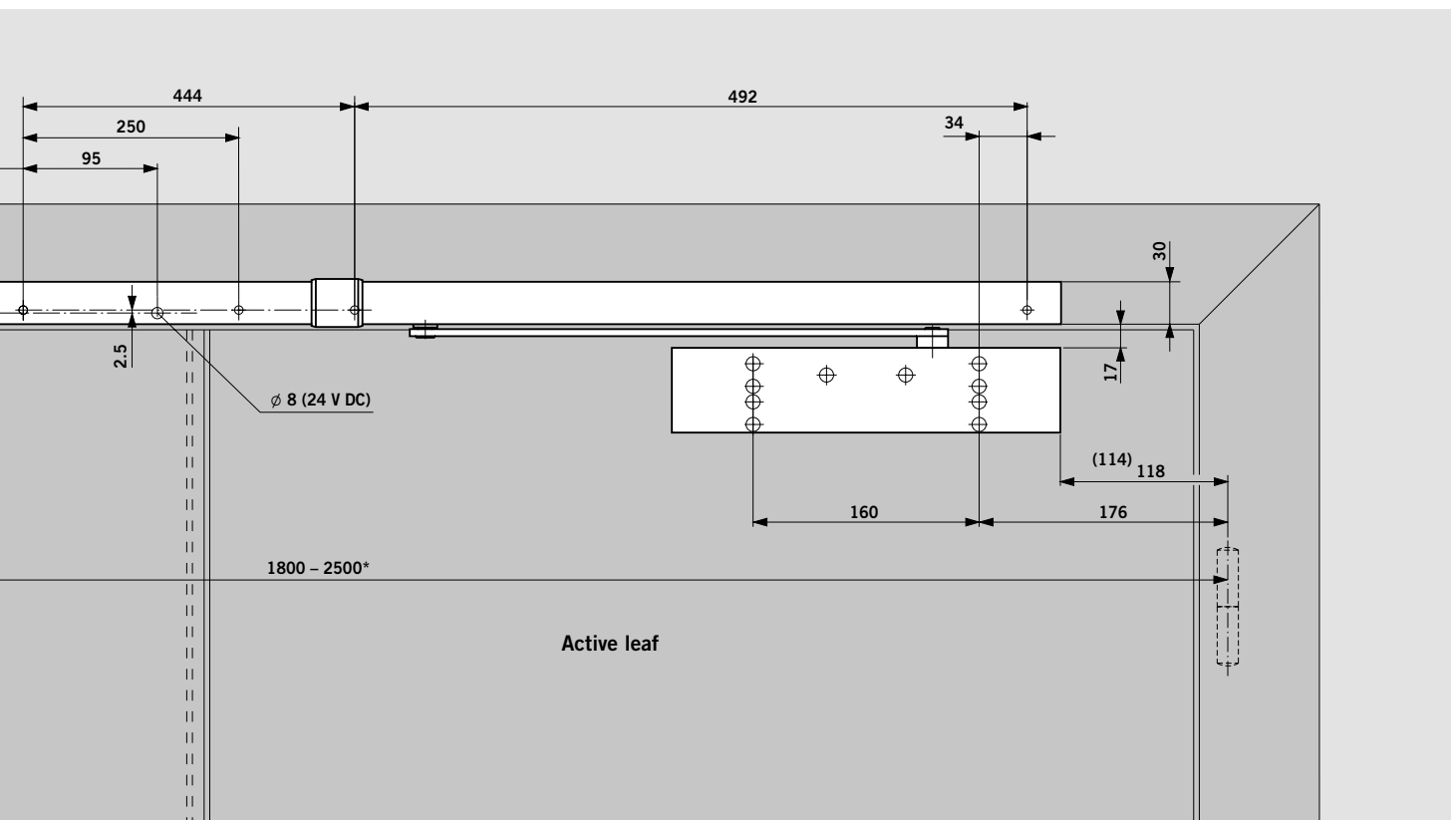
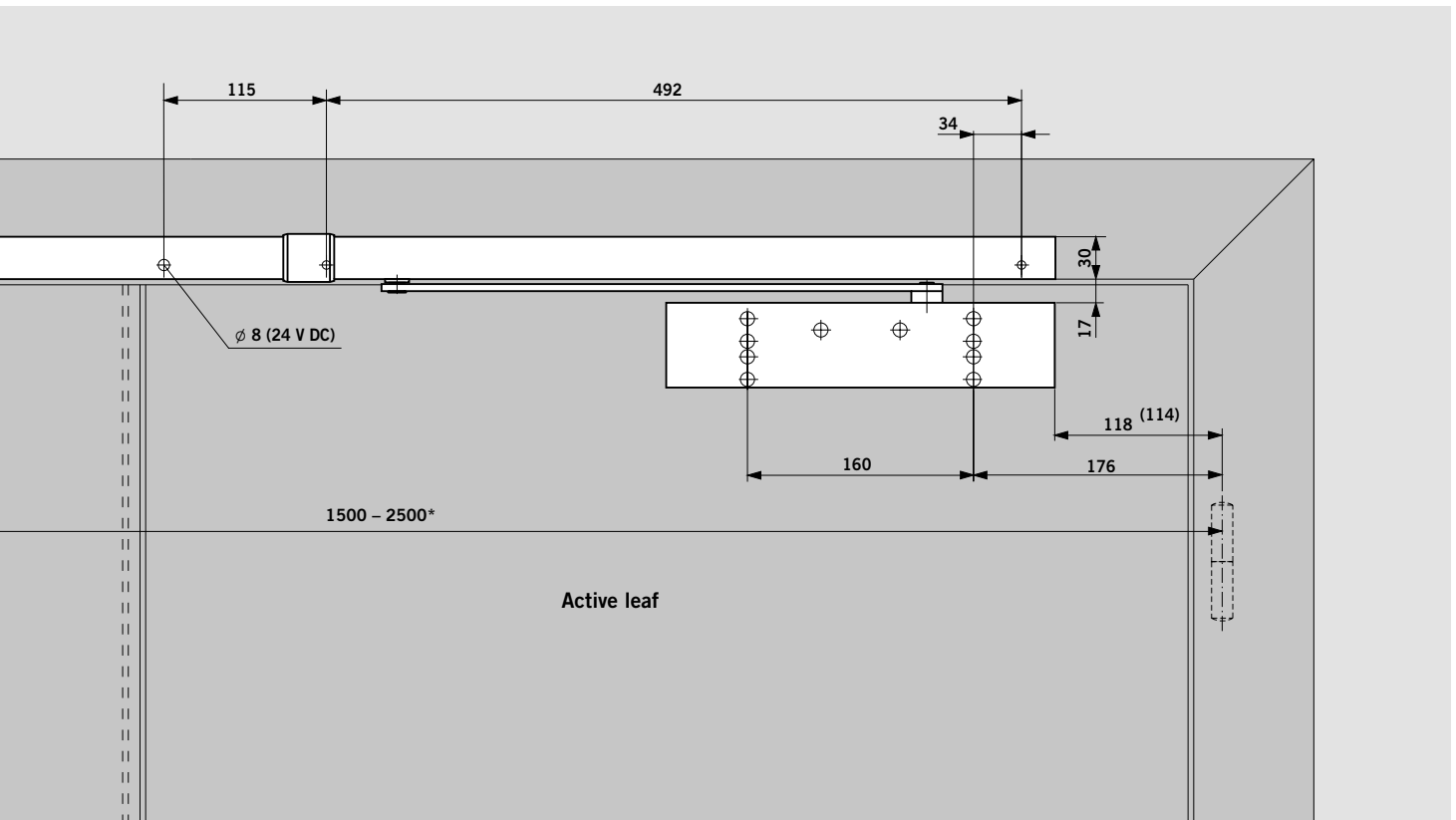

\* In the case of particularly large and heavy doors, we recommend that DORMA EM hold-open magnets be employed instead of the electro-mechanical hold-open unit.

# SMOKE DETECTORS

The RMZ and RM-N smoke detectors provide the ideal complement to the TS 93 system for passive/preventive fire protection. They are designed in accordance with the latest codes issued by the

German Institute for Building Technology and ensure perfect interaction between all the devices employed for holding open fire and smoke check doors – whatever the situation.

## RMZ

The RMZ smoke detector in the Contur design provides a 24V DC supply for all the hold-open devices connected to it. In the event of an alarm or power failure, it de-energises the devices (release function). It has an automatic reset which can be switched to manual mode if required. A floating (no-volt) change-over contact and connections for both further detectors and for an external manual release device are also

provided. The unit is available in the RMZ version with a stabilised power pack, or in the RMZ DCW® version without a power pack for integration in building management and control systems via a DCW® bus and the DORMA TMS door management system.

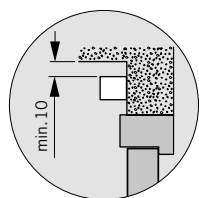
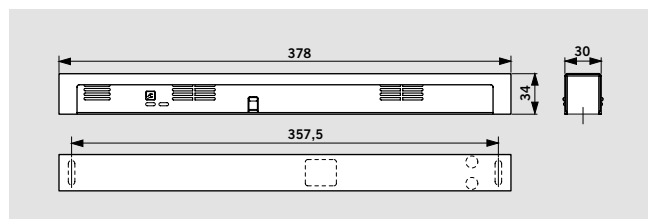

## RM-N

The RM-N smoke detector ensures the early detection both of smouldering fires and open fires with smoke evolution. It can be connected to all DORMA hold-open systems.

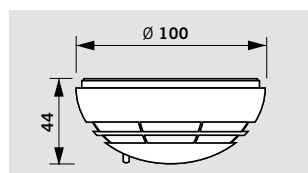

| Data and features   |  | RMZ                | RM-N               |
|---|--|--------------------|--------------------|
| Functions   | Smoke detector                               | ●                  | ●                  |
|   | Release device                               | ●                  | –                  |
|   | Power supply unit                            | ●                  | –                  |
| Smoke detection   | Scattered light principle (optical sensor)   | ●                  | ●                  |
| Fixing  | Lintel or transom-mounted                    | ●                  | –                  |
|   | Ceiling-mounted                              | –                  | ●                  |
| Connection of other detectors   |  | ●                  | –                  |
| Total installed load (max.) for hold-open device and other detectors in W |  | 9.8                | –                  |
| Power consumption of internal detectors in W                              |  | 1.2                | 0.65               |
| LED indicators  | Alarm  | ●                  | ●                  |
|   | Standby                                      | ●                  | –                  |
|   | Maintenance due                              | ●                  | –                  |
|   | Contaminated                                 | ●                  | –                  |
| Input voltage   |  | 230 V AC ± 10 %    | 24 V DC +15%, -10% |
| Output voltage  |  | 24 V DC            | –                  |
| Detector operating voltage  |  | 24 V DC +15%, -10% | 24 V DC            |
| Input current (max.) in mA  |  | 75                 | 20                 |
| Floating (no-volt) change-over contact Safety extra low voltage (SELV)    |  | 24 V AC/DC 2 A     | 30 V AC/DC 1 A     |
| Reset   | Automatic                                    | ●                  | ●                  |
|   | Can be changed to manual reset <sup>1)</sup> | ●                  | –                  |
| Functional check  | Smoke detection                              | ●                  | ●                  |
| Connection terminals for external manual release                          |  | ●                  | –                  |
| Degree of protection  |  | IP 30              | IP 43              |
| Ambient temperature in °C   |  | –20, +40           | –10, +60           |
| Weight in kg  |  | 0.25               | 0.15               |
| Dimensions in mm  | Length                                       | 379                | ∅ 100              |
|   | Overall depth                                | 34                 |                    |
|   | Height                                       | 30                 | 44                 |
| Compliant with EN 54 Part 7   |  | ●                  | ●                  |
| CE mark for building products   |  | ●                  | ●                  |

● Yes – No

<sup>1)</sup> Required in connection with TS 99 FL and ITS 96 FL

## F Approval certification

The RMZ and RM-N smoke detectors have been granted general building approval by the German Institute for Building Technology, Berlin; acceptance inspection mandatory in Germany.

RMZ + 2x RM-N

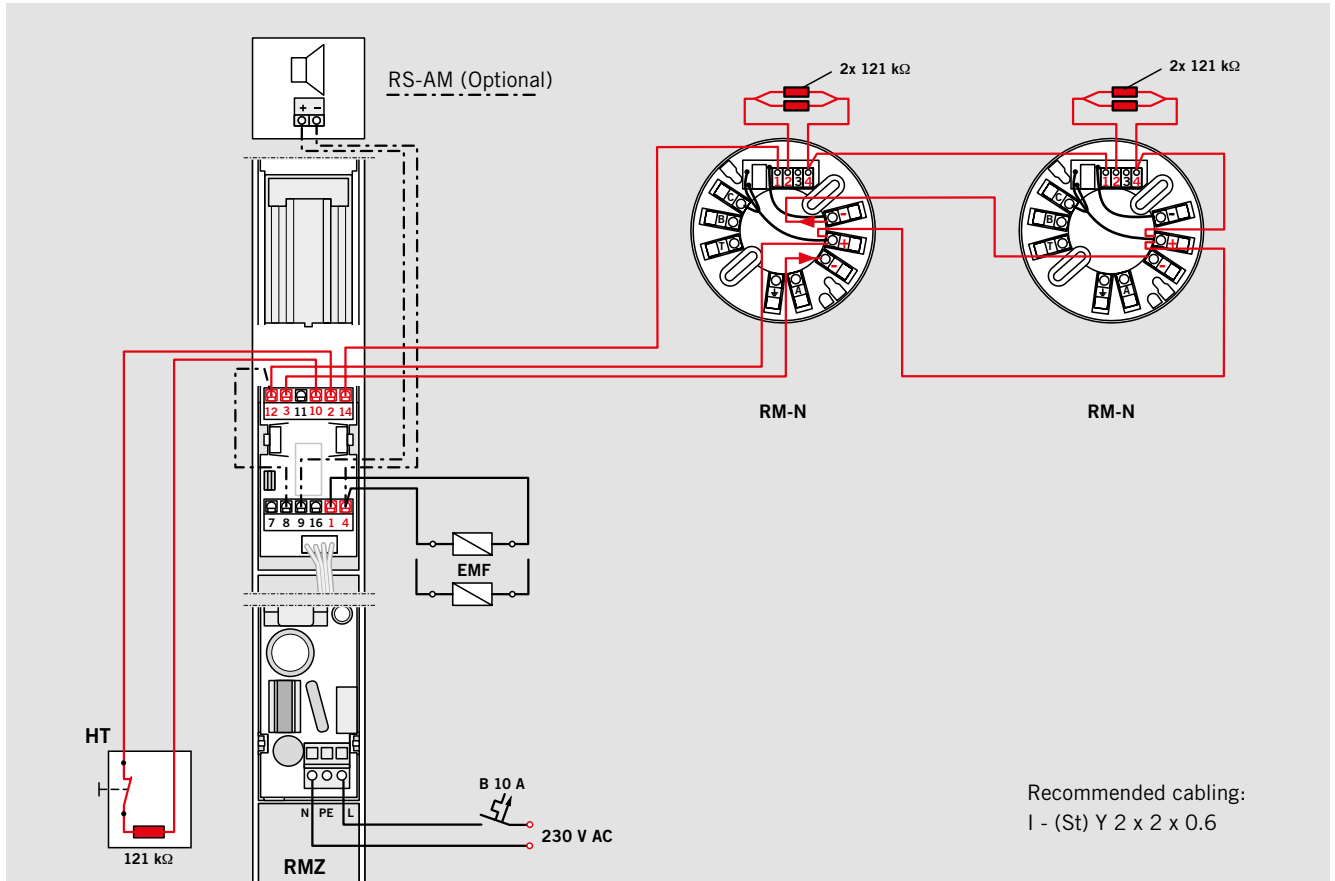

G-SR-EMR + 2x RM-N

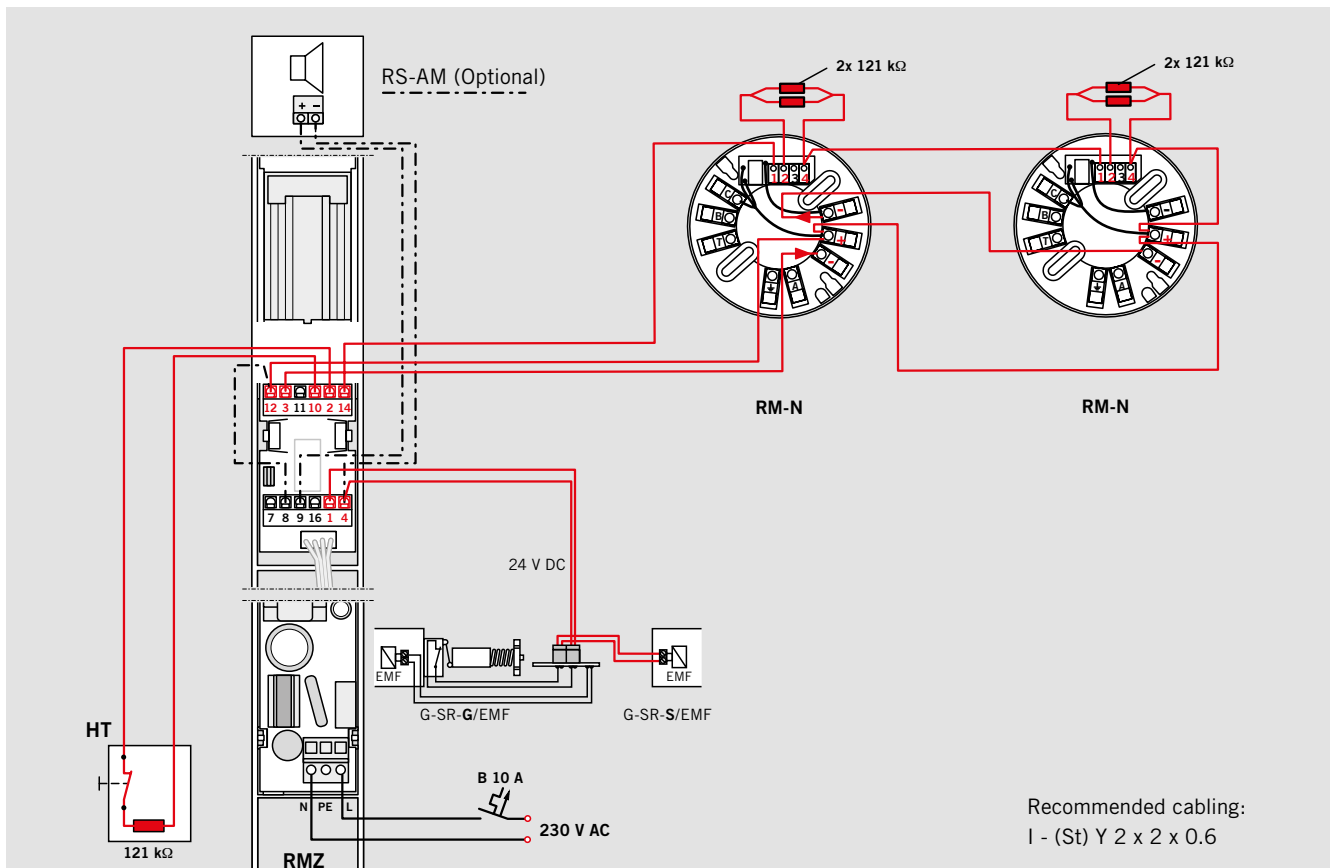

# ACCESSORIES FOR SINGLE DOORS

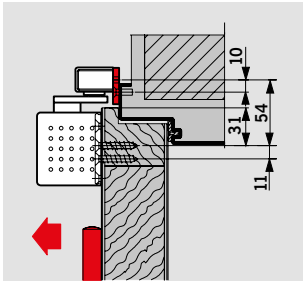

### 30 mm mounting backplate for G-N

For fixing the slide channel to the door frame where direct fixing is not possible.

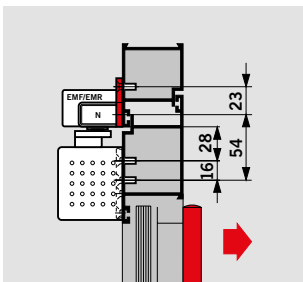
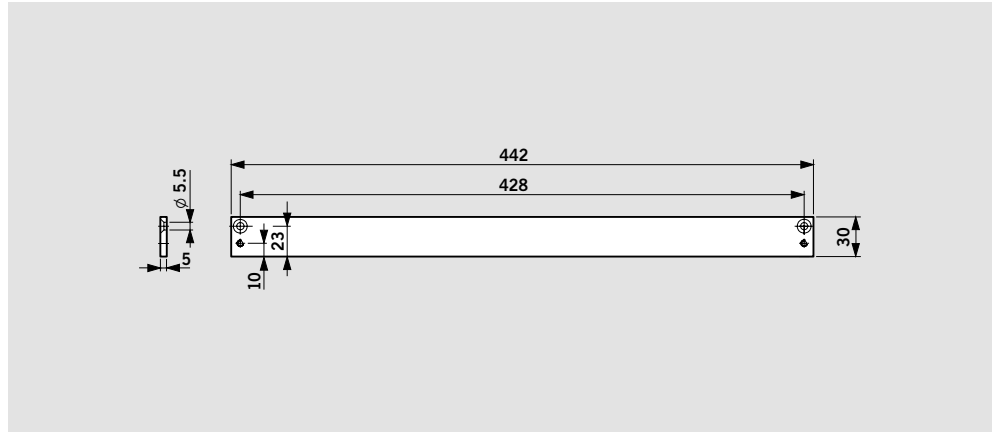

### 40 mm mounting backplate for G-N, EMF, EMR

For fixing the slide channel to the door frame where direct fixing is not possible.

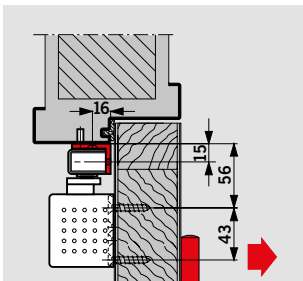
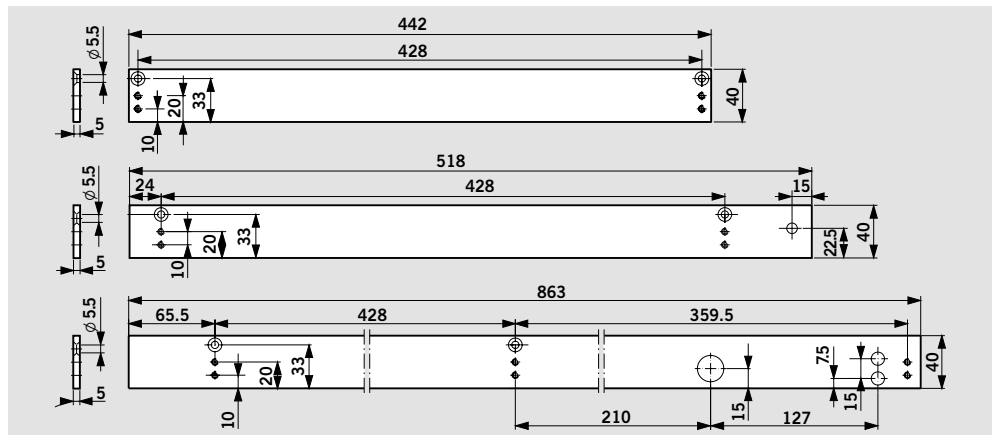

### Angle bracket for G-N

For push-side fixing of the slide channel to door frames with a deep reveal.

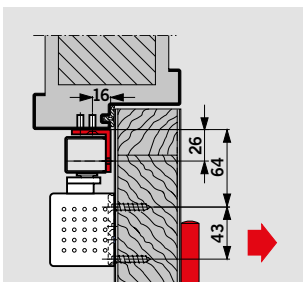
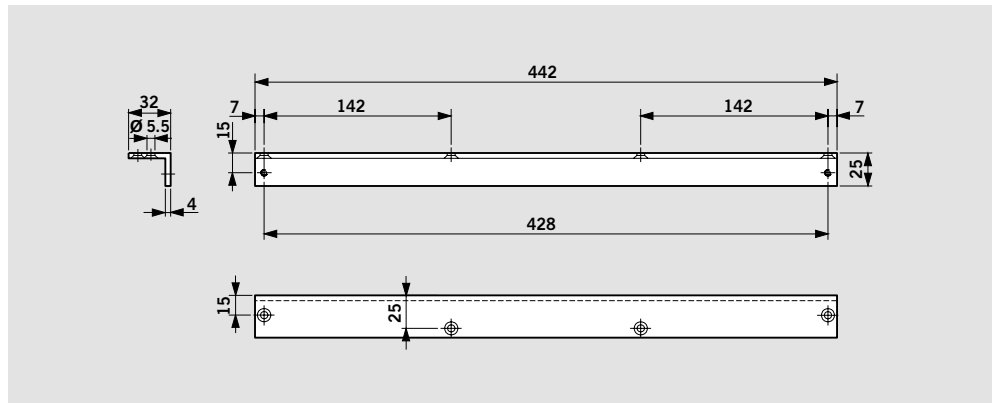

### Angle bracket for G-EMF

For push-side fixing of the slide channel to door frames with a deep reveal.

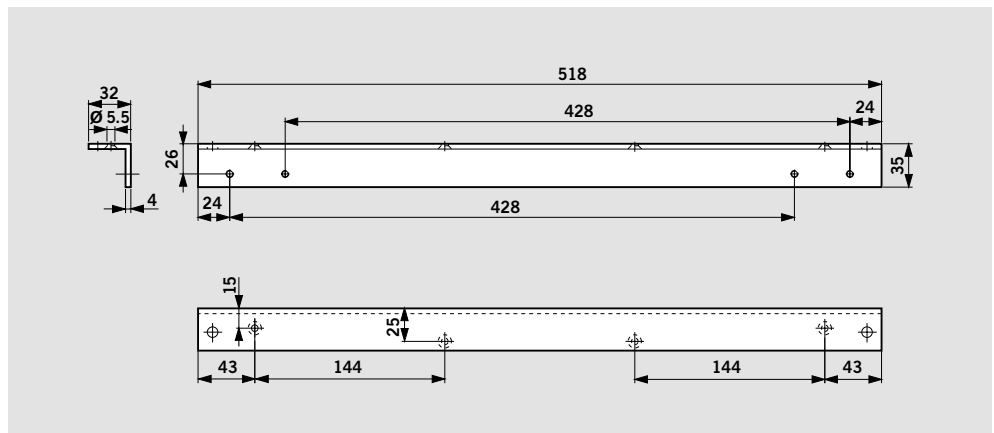



# ACCESSORIES FOR DOUBLE DOORS

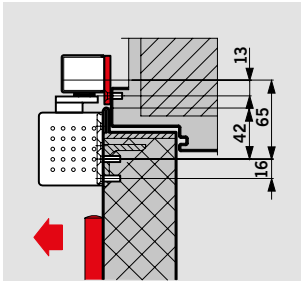

## 40 mm mounting backplate for G-SR

For fixing the slide channels to the door frame where direct fixing is not possible.

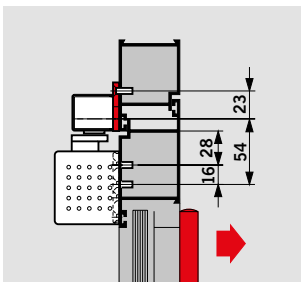
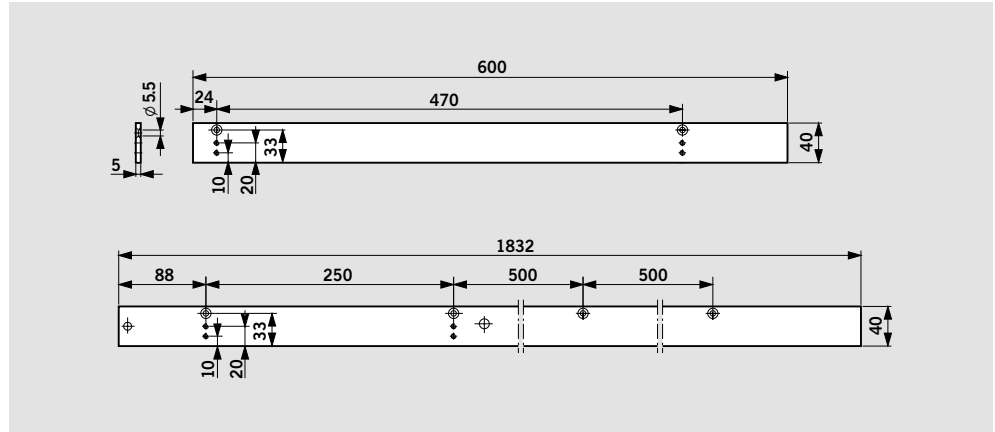

## 40 mm mounting backplate for G-SR/BG

For fixing the slide channels to the door frame where direct fixing is not possible.

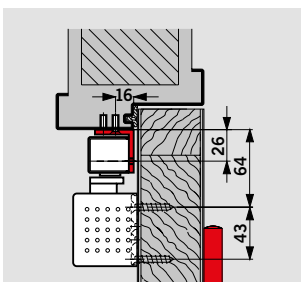
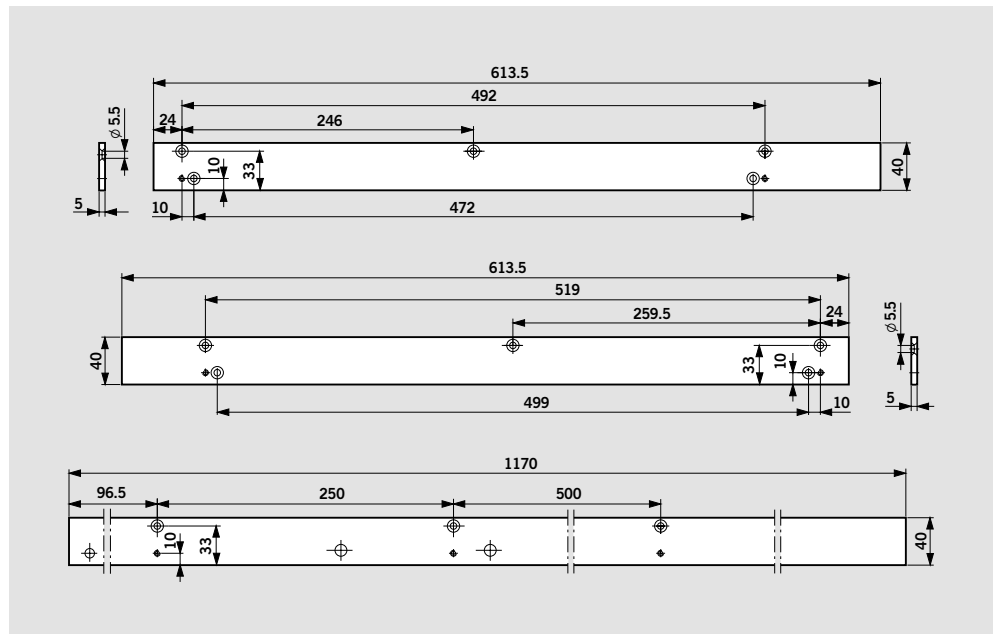

## Angle bracket for G-SR/BG

For fixing the slide channels to door frames with a deep reveal.

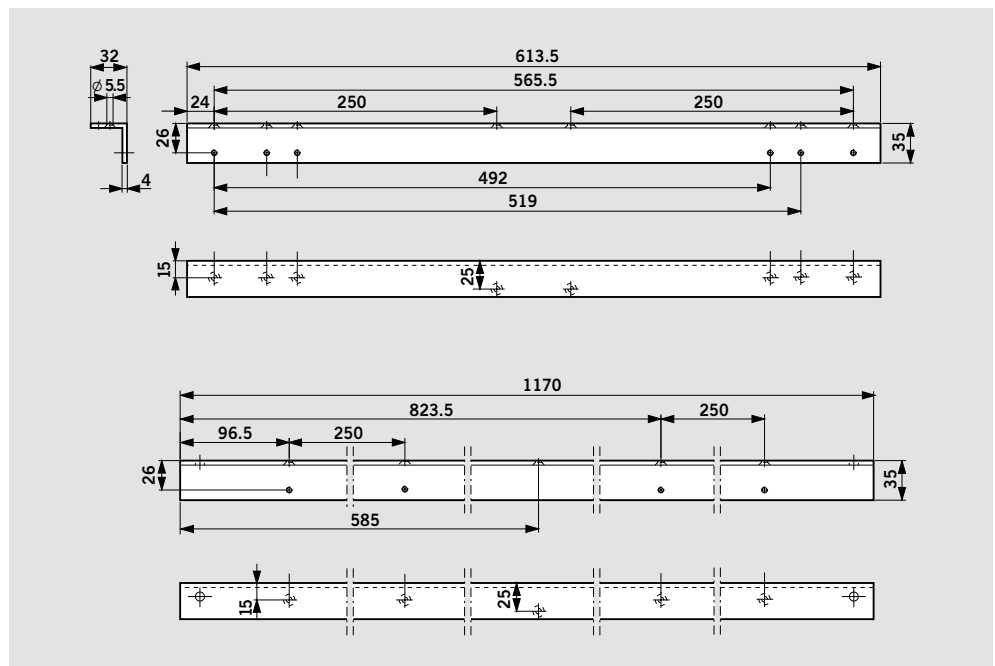



# HOLD-OPEN SYSTEMS REGULATIONS / INFORMATION

The use of hold-open systems is subject to special regulations based on official approval requirements. These relate in particular to the final inspection (acceptance), continuous monitoring and maintenance.

The regulations and instructions provided below are intended as an aid, pursuant to statutory regulations that apply e.g. in Germany, to ensure that all participants are properly informed of the most important requirements that relate to the installation and operation of hold-open systems.

Further information can be found in the following documents:

- Richtlinien für Feststellungen des Deutschen Instituts für Bautechnik, Berlin [Code of practice relating to hold-open systems issued by the German Institute for Building Technology, Berlin]
- General building regulations pertaining to the approval of the hold-open system concerned
- EN 1155
- EN 14637

## 1. General

**1.1** In the case of fire doors (and similar shutters/closures/barriers) that are held open by hold-open systems, the sweep area necessary for the closing operation must be kept constantly clear. This area must be clearly identified by lettering, floor markings or similar. Where necessary, structural measures must also be implemented to ensure that cables, leads, lines,

pipes, stored/deposited goods or components (e.g. false ceilings or other overhead items/elements) are reliably prevented from falling into the sweep area.

**1.2** Wherever possible, smoke detectors should be used for hold-open systems. For hold-open systems for fire doors in emergency escape routes, smoke detectors must be used.

**1.3** Each hold-open device must also be capable of being released by hand, without adversely affecting the functional capabilities of the automatic release device. In the case of door closers with electro-magnetic hold-open, the manual release may be performed by a small tug applied to the door leaf. If holding electro-magnets or free-swing door

closers are used, a pushbutton must be provided to facilitate manual release. The manual release push-buttons employed for this purpose must be red and carry the wording "Close Door" or equivalent. The pushbutton must be located in the immediate vicinity of the door and must not be concealed by the door when this is held open.

## 2. Commissioning

**2.1** In Germany and countries governed by DIN regulations: Following on-site installation of the operable hold-open system, its functional integrity and quality of installation must be confirmed by an acceptance inspection procedure. The acceptance inspection may only be performed by skilled personnel of manufacturers of monitoring

and/or hold-open devices, skilled personnel authorized by same, or skilled personnel from an accredited inspection agency.

**2.2** In Germany and countries governed by DIN regulations: Once the acceptance inspection has been successfully completed, the operator shall permanently fix on the wall, in the

immediate vicinity of the door, a plate supplied by the manufacturer of the hold-open system measuring 105 mm x 52 mm and carrying the inscription Hold-open system Inspected by... (company logo with month and year of acceptance inspection) or equivalent

**2.3** The operator is to be provided with a certificate detailing the successful acceptance inspection; this certificate must be retained by the operator.

## 3. Routine Inspection









**3.1** The hold-open system must be kept by the operator in a constantly good operating condition, and inspected at least once a month to ensure that it is functioning properly.





**3.2** In addition, the operator is obliged at least once a year, or at shorter intervals if specified in the approval certificate, to inspect all the devices to ensure that they are operating and interacting properly and without

fault, and to carry out or instigate adequate maintenance. The associated test, inspection and the maintenance work may only be performed by an expert or an appropriately trained person.

**3.3** The scope, result and time of the periodic inspection are to be recorded. These records must be retained by the operator.

# RANGE OF EQUIPMENT AND OPTIONAL ACCESSORIES SINGLE DOORS

|  |                                   | TS 93 B   | TS 93 G  | 30 mm mounting backplate for G-N  | 40 mm mounting backplate for G-N  |
|--|-----------------------------------|---|--|---|---|
|  |                                   |  |  |  |  |
|  |                                   | 2-5<br>■ 430200xx<br>5-7<br>■ 435200xx  | 2-5<br>■ 430300xx<br>5-7<br>■ 435300xx   | 644000xx  | 644100xx  |
| Product description: see page  |                                   | 6   | 7  | 24  | 24  |
| <b>G-N</b><br>          | <input type="checkbox"/> 640100xx | 8   | <input type="checkbox"/> <input checked="" type="checkbox"/>                       | <input type="checkbox"/> <input checked="" type="checkbox"/>                        | <input type="checkbox"/> <input checked="" type="checkbox"/>                        |
| <b>G-EMF</b><br>        | <input type="checkbox"/> 640800xx | 10  | <input type="checkbox"/> <input checked="" type="checkbox"/>                       | <input type="checkbox"/> <input checked="" type="checkbox"/>                        | <input type="checkbox"/> <input checked="" type="checkbox"/>                        |
| <b>G-EMR</b><br>      | <input type="checkbox"/> 640700xx | 12  | <input type="checkbox"/> <input checked="" type="checkbox"/>                       | <input type="checkbox"/> <input checked="" type="checkbox"/>                        | <input type="checkbox"/> <input checked="" type="checkbox"/>                        |
| <b>G-EMR DCW®</b><br> | <input type="checkbox"/> 640703xx | 12  | <input type="checkbox"/> <input checked="" type="checkbox"/>                       | <input type="checkbox"/> <input checked="" type="checkbox"/>                        | <input type="checkbox"/> <input checked="" type="checkbox"/>                        |

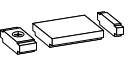
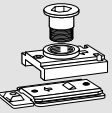
| 40 mm mounting backplate for G-EMF  | 40 mm mounting backplate for G-EMR  | Angle bracket for G-N   | Angle bracket for G-EMF   | Cushioned limit stay set for G-N   | Add-on old-open unit for G-N  |
|---|---|---|---|--|---|
|  |  |  |  |  |  |
| 644200xx  | 644600xx  | 644300xx  | 644400xx  | 35800093   | 18570000  |
| 24  | 24  | 24  | 24  | 8  | 8   |
|   |   | △   |   | △  | △   |
| △   |   |   | △   |  |   |
|   | △   |   |   |  |   |
|   | △   |   |   |  |   |

**Smoke detector system**

**RMZ**  
648000xx  
**RMZ DCW®**  
648003xx

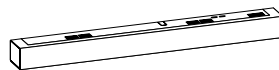

**RM-N**  
64830900  
packaging unit 2 pcs.

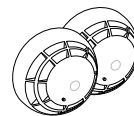

Product description: see page 22

**xx Colour**

- 01 Silver
- 11 White (RAL 9016)
- 10 White (RAL 9010)
- 09 Special colour

Also available in matching "Design" finishes













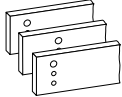
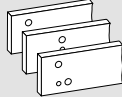

- 04 Stainless steel
- 05 Polished brass

\* "Design" refers to the surface finish of the products

- Hold-open device – tested to EN 1155 (max. EN 5)
- Smoke detector
- xx Colour
- Closer separate
- Slide channel assembly separate
- △ Optional accessory

# RANGE OF EQUIPMENT AND OPTIONAL ACCESSORIES

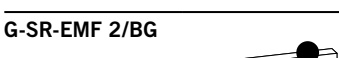
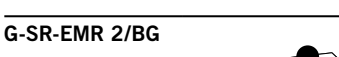
## DOUBLE DOORS

|  |   | TS 93 B   |                          | TS 93 G   |           | Mounting backplate<br>for G-SR  | Mounting backplate<br>for G-SR/BG   |
|--|---|---|--------------------------|---|-----------|---|---|
| Active leaf  | Inactive leaf   | <br>2-5<br>■ 430200xx<br>5-7<br>■ 435200xx |                          | <br>2-5<br>■ 430300xx |           | <br>644800xx | <br>644900xx |
| <b>Product description: see page</b>   |   |   | <b>6</b>                 | <b>7</b>  | <b>25</b> | <b>25</b>   |   |
| <b>G-SR</b><br>                 | <input type="checkbox"/> VK 641010xx<br><input type="checkbox"/> V 641020xx<br><input type="checkbox"/> VL 641030xx | 14  | <input type="checkbox"/> | 2 x ■   |           | △   |   |
| <b>G-SR-EMF 1</b><br>           | <input type="checkbox"/> VK 641110xx<br><input type="checkbox"/> V 641120xx<br><input type="checkbox"/> VL 641130xx | 14  | <input type="checkbox"/> | 2 x ■   |           | △   |   |
| <b>G-SR-EMF 2</b><br>           | <input type="checkbox"/> VK 641310xx<br><input type="checkbox"/> V 641320xx<br><input type="checkbox"/> VL 641330xx | 14  | <input type="checkbox"/> | 2 x ■   |           | △   |   |
| <b>G-SR-EMF 1G</b><br>        | <input type="checkbox"/> VK 641210xx<br><input type="checkbox"/> V 641220xx<br><input type="checkbox"/> VL 641230xx | 14  | <input type="checkbox"/> | 2 x ■   |           | △   |   |
| <b>G-SR-EMR 1</b><br>         | <input type="checkbox"/> V 642150xx<br><input type="checkbox"/> VL 642160xx   | 14  | <input type="checkbox"/> | 2 x ■   |           | △   |   |
| <b>G-SR-EMR 2</b><br>         | <input type="checkbox"/> V 642350xx<br><input type="checkbox"/> VL 642360xx   | 14  | <input type="checkbox"/> | 2 x ■   |           | △   |   |
| <b>G-SR-EMR 2 DCW®</b><br>    | <input type="checkbox"/> V 642353xx<br><input type="checkbox"/> VL 642363xx   | 14  | <input type="checkbox"/> | 2 x ■   |           | △   |   |
| <b>G-SR-EMR 1G</b><br>        | <input type="checkbox"/> V 642250xx<br><input type="checkbox"/> VL 642260xx   | 14  | <input type="checkbox"/> | 2 x ■   |           | △   |   |
| <b>G-SR/BG</b><br>            | <input type="checkbox"/> V 641440xx   | 18  |                          | <input type="checkbox"/>  | 2 x ■     |   | △   |
| <b>G-SR-EMF 2/BG</b><br>      | <input type="checkbox"/> V 641740xx   | 18  |                          | <input type="checkbox"/>  | 2 x ■     |   | △   |
| <b>G-SR-EMR 2/BG</b><br>      | <input type="checkbox"/> V 642770xx   | 18  |                          | <input type="checkbox"/>  | 2 x ■     |   | △   |
| <b>G-SR-EMR 2 DCW®/BG</b><br> | <input type="checkbox"/> V 642773xx   | 18  |                          | <input type="checkbox"/>  | 2 x ■     |   | △   |



## SPECIFICATION TEXT SINGLE DOORS

### TS 93 N EN 2-5 / EN 5-7

Cam action door closer conforming to EN 1154, carries the CE mark, Contur design, with rapidly decreasing opening torque/force. Door leaf fixing on the pull side, transom fixing on the push side. Closing speed, latching speed, hydraulically controlled backcheck and delayed action conveniently adjustable at valves accessible from the front.

Mounting bracket with universal fixing hole system. Non-handed. Height-adjustable slide channel.

#### Optional

- With retrofittable cushioned limit stay for integration in the standard slide channel.
- With retrofittable mechanical hold-open unit (RF), hold-open point adjustable between 75° and 150°.

**Use of mechanical hold-open units is not permitted on fire and smoke check doors.**

#### Colour

- silver
- white, sim. to RAL  9010  9016
- stainless steel
- polished brass
- special colour (sim. to RAL)

#### Make

DORMA TS 93 N, EN 2-5  
DORMA TS 93 N, EN 5-7  
DORMA TS 93 RF, EN 2-5  
DORMA TS 93 RF, EN 5-7

### TS 93G N EN 2-5 / EN 5-7

Cam action door closer conforming to EN 1154, carries the CE mark, Contur design, with rapidly decreasing opening torque/force. Door leaf fixing on the push side, transom fixing on the pull side. Closing speed, latching speed, hydraulically controlled backcheck and delayed action conveniently adjustable at valves accessible from the front.

Mounting bracket with universal fixing hole system. Non-handed. Height-adjustable slide channel.

#### Optional

- With retrofittable cushioned limit stay for integration in the standard slide channel.
- With retrofittable mechanical hold-open unit (RF), hold-open point adjustable between 75° and 150°.

**Use of mechanical hold-open units is not permitted on fire and smoke check doors.**

#### Colour

- silver
- white, sim. to RAL  9010  9016
- stainless steel
- polished brass
- special colour (sim. to RAL)

#### Make

DORMA TS 93G N, EN 2-5  
DORMA TS 93G N, EN 5-7  
DORMA TS 93G RF, EN 2-5  
DORMA TS 93G RF, EN 5-7

### TS 93 EMF EN 2-5

Cam action door closer conforming to EN 1154, carries the CE mark, Contur design, with rapidly decreasing opening torque/force. Pull-side fixing. Closing speed, latching speed, hydraulically controlled backcheck and delayed action conveniently adjustable at valves accessible from the front.

Mounting bracket with universal fixing hole system. Non-handed. Slide channel assembly with integral electro-mechanical hold-open, 24 V DC, conforming to EN 1155. Hold-open point (80° – 140°) and pull-off force infinitely variable. One-piece cover. Overall height 30 mm.

Approved by the German Institute for Building Technology, Berlin, for use in hold-open systems. Acceptance inspection of the system is mandatory.

#### Colour

- silver
- white, sim. to RAL  9010  9016
- stainless steel
- polished brass
- special colour (sim. to RAL)

#### Make

DORMA TS 93 EMF, EN 2-5

### TS 93G EMF EN 2-5

Cam action door closer conforming to EN 1154, carries the CE mark, Contur design, with rapidly decreasing opening torque/force. Push-side fixing. Closing speed, latching speed, hydraulically controlled backcheck and delayed action conveniently adjustable at valves accessible from the front.

Mounting bracket with universal fixing hole system. Non-handed. Slide channel assembly with integral electro-mechanical hold-open, 24 V DC, conforming to EN 1155. Hold-open point (80° – 140°) and pull-off force infinitely variable. One-piece cover. Overall height 30 mm.

Approved by the German Institute for Building Technology, Berlin, for use in hold-open systems. Acceptance inspection of the system is mandatory.

#### Colour

- silver
- white, sim. to RAL  9010  9016
- stainless steel
- polished brass
- special colour (sim. to RAL)

#### Make

DORMA TS 93G EMF, EN 2-5



**TS 93 EMR** EN 2-5

Cam action door closer conforming to EN 1154, carries the CE mark, Contur design, with rapidly decreasing opening torque/force. Pull-side fixing. Closing speed, latching speed, hydraulically controlled backcheck and delayed action conveniently adjustable at valves accessible from the front. Mounting bracket with universal fixing hole system. Non-handed. Slide channel assembly with integral smoke detector featuring standby and maintenance

indicators and electro-mechanical hold-open, 24 V DC, conforming to EN 1155. Hold-open point (80° – 140°) and pull-off force infinitely variable. A floating (volt-free) alarm contact and connections for further detectors and external manual release devices are provided. One-piece cover. Overall height 30 mm. Approved by the German Institute for Building Technology, Berlin, for use as a hold-open unit. Acceptance inspection of the system is mandatory.

**Model**

- TS 93 EMR with integrated power pack. Power supply 230 V AC, operating voltage 24 V DC
- TS 93 EMR DCW® Smoke detector without power pack for connection to DCW® bus.
- Optional integral alarm module adding an audible signal to the visual indicator.

**Colour**

- silver
- white, sim. to RAL  9010  9016
- stainless steel
- polished brass
- special colour (sim. to RAL)

**Make**

DORMA TS 93 EMR, EN 2-5  
DORMA TS 93 EMR DCW®, EN 2-5

**TS 93G EMR** EN 2-5

Cam action door closer conforming to EN 1154, carries the CE mark, Contur design, with rapidly decreasing opening torque/force. Push-side fixing. Closing speed, latching speed, hydraulically controlled backcheck and delayed action conveniently adjustable at valves accessible from the front. Mounting bracket with universal fixing hole system. Non-handed. Slide channel assembly with integral smoke detector featuring standby and maintenance indicators, power pack and

electro-mechanical hold-open, 24 V DC, conforming to EN 1155. Hold-open point (80° – 140°) and pull-off force infinitely variable. A floating (volt-free) alarm contact and connections for further detectors and external manual release devices are provided. One-piece cover. Overall height 30 mm. Approved by the German Institute for Building Technology, Berlin, for use as a hold-open unit. Acceptance inspection of the system is mandatory.

**Model**

- TS 93G EMR with integrated power pack. Power supply 230 V AC, operating voltage 24 V DC
- TS 93G EMR DCW® Smoke detector without power pack for connection to DCW® bus.
- Optional integral alarm module adding an audible signal to the visual indicator.

**Colour**

- silver
- white, sim. to RAL  9010  9016
- stainless steel
- polished brass
- special colour (sim. to RAL)

**Make**

DORMA TS 93G EMR, EN 2-5  
DORMA TS 93G EMR DCW®, EN 2-5

**RMZ**

Smoke detector, Contur design, with standby and maintenance indicators, integral power pack and optical smoke sensor for transom/lintel fixing. For activation of DORMA hold-open devices. A floating (volt-free) alarm contact and connections for further detectors and external manual release devices are provided.

Can be switched to manual reset. One-piece cover. Overall height 30 mm. Approved by the German Institute for Building Technology, Berlin, for use in a hold-open system. Acceptance inspection of the system is mandatory.

**Model**

- RMZ with integrated power pack. Power supply 230 V AC, operating voltage 24 V DC
- RMZ DCW® Smoke detector without power pack for connection to DCW® bus.
- Optional integral alarm module adding an audible signal to the visual indicator.

**Colour**

- silver
- white, sim. to RAL  9010  9016
- stainless steel
- polished brass
- special colour (sim. to RAL)

**Make**

DORMA RMZ  
DORMA RMZ DCW®

**RM-N**

Optical smoke detector, 24V DC, for ceiling fixing. For use as second and third triggering detector on all DORMA hold-open systems. With floating (no-volt) changeover

contact. General building approval granted by DIBt, Berlin and the VdS, Cologne; compliant to EN 54, Part 7. Acceptance inspection mandatory in Germany.

**Colour**

- white, sim. to RAL 9003

**Make**

DORMA RM-N

# SPECIFICATION TEXT DOUBLE DOORS

## TS 93 GSR EN 2-5

Cam action door closer conforming to EN 1154, carries the CE mark, Contur design, with rapidly decreasing opening torque/force. Pull-side fixing. Closing speed, latching speed, hydraulically controlled backcheck and delayed action conveniently adjustable at

valves accessible from the front. Mounting bracket with universal fixing hole system. Non-handed. Slide channel assembly with integrated mechanical door co-ordinator, conforming to EN 1158. This system operates independently of the door closer hydraulics using a push rod

clamping system with an overload release and one-piece cover. Overall height 30 mm. Non-handed. Approved by the German Institute for Building Technology, Berlin, for use on fire and smoke check doors.

### Colour

- silver
- white, sim. to RAL 9016
- stainless steel
- special colour (sim. to RAL)

### Make

DORMA TS 93 GSR

## TS 93 GSR-EMF EN 2-5

Cam action door closer conforming to EN 1154, carries the CE mark, Contur design, with rapidly decreasing opening torque/force. Pull-side fixing. Closing speed, latching speed, hydraulically controlled backcheck and delayed action conveniently adjustable at valves accessible from the front. Mounting bracket with universal fixing hole system. Non-handed. Slide channel assembly with integrated mechanical door co-ordinator, conforming to EN 1158. With electro-mechanical

hold-open, 24 V DC, conforming to EN 1155. Hold-open point (80° – 130°) and pull-off force infinitely variable. This system operates independently of the door closer hydraulics using a push rod clamping system with an overload release and one-piece cover. Overall height 30 mm. Non-handed. Approved by the German Institute for Building Technology, Berlin, for use in hold-open systems. Acceptance inspection of the system is mandatory.

### Model

- TS 93 GSR-EMF 1  
With electro-mechanical hold-open for the inactive leaf
- TS 93 GSR-EMF 2  
With electro-mechanical hold-open for the active and inactive leaf
- TS 93 GSR-EMF 1G  
With electro-mechanical hold-open for the active leaf

### Colour

- silver
- white, sim. to RAL 9016
- stainless steel
- special colour (sim. to RAL)

### Make

DORMA TS 93 GSR-EMF 1  
DORMA TS 93 GSR-EMF 2  
DORMA TS 93 GSR-EMF 1G

## TS 93 GSR-EMR EN 2-5

Cam action door closer conforming to EN 1154, carries the CE mark, Contur design, with rapidly decreasing opening torque/force. Pull-side fixing. Closing speed, latching speed, hydraulically controlled backcheck and delayed action conveniently adjustable at valves accessible from the front. Mounting bracket with universal fixing hole system. Non-handed. Smoke detector with standby and maintenance indicators, fully integrated in the door co-ordinator body. A floating (voltage-free) alarm contact and connections for further detectors and external manual release devices are provided. Power supply 230 V AC, operating

voltage 24 V DC. Slide channel assembly with integrated mechanical door co-ordinator, conforming to EN 1158. With electro-mechanical hold-open, 24 V DC, conforming to EN 1155. Hold-open point (80° – 130°) and pull-off force infinitely variable. This system operates independently of the door closer hydraulics using a push rod clamping system with an overload release and one-piece cover. Overall height 30 mm. Non-handed. Approved by the German Institute for Building Technology, Berlin, for use as a hold-open unit. Acceptance inspection of the system is mandatory.

### Model

- TS 93 GSR-EMR 1  
With electro-mechanical hold-open for the inactive leaf
- TS 93 GSR-EMR 2  
With electro-mechanical hold-open for the active and inactive leaf
- TS 93 GSR-EMR 1G  
With electro-mechanical hold-open for the active leaf
- TS 93 GSR-EMR 2 DCW®  
Smoke detector without power pack for connection to DCW® bus. With electro-mechanical hold-open for the active and inactive leaf.

### Colour

- silver
- white, sim. to RAL 9016
- stainless steel
- special colour (sim. to RAL)

### Make

DORMA TS 93 GSR-EMR 1  
DORMA TS 93 GSR-EMR 2  
DORMA TS 93 GSR-EMR 1G  
DORMA TS 93 GSR-EMR 2  
DCW®

**TS 93 GSR/BG** EN 2-5

Cam action door closer conforming to EN 1154, carries the CE mark, Contur design, with rapidly decreasing opening torque/force. Push-side fixing. Closing speed, latching speed, hydraulically controlled backcheck and delayed action conveniently adjustable at

valves accessible from the front. Mounting bracket with universal fixing hole system. Non-handed. Slide channel assembly with integrated mechanical door co-ordinator, conforming to EN 1158. This system operates independently of the door closer hydraulics using a push rod

clamping system with an overload release and one-piece cover. Overall height 30 mm. Non-handed. General building approval issued by the German Institute for Building Technology, Berlin, for use on fire and smoke check doors.

**Colour**

- silver
- white, sim. to RAL 9016
- stainless steel
- special colour (sim. to RAL)

**Make**

DORMA TS 93 GSR/BG

**TS 93 GSR-EMF 2/BG** EN 2-5

Cam action door closer conforming to EN 1154, carries the CE mark, Contur design, with rapidly decreasing opening torque/force. Push-side fixing. Closing speed, latching speed, hydraulically controlled backcheck and delayed action conveniently adjustable at valves accessible from the front. Mounting bracket with universal fixing hole system. Non-handed. Slide channel assembly with

integrated mechanical door co-ordinator, conforming to EN 1158. With electro-mechanical hold-open for the active and inactive leaf, 24 V DC, conforming to EN 1155. Hold-open point (80° – 120°) and pull-off force infinitely variable. This system operates independently of the door closer hydraulics using a push rod

clamping system with an overload release and one-piece cover. Overall height 30 mm. Non-handed. Approved by the German Institute for Building Technology, Berlin, for use in hold-open systems. Acceptance inspection of the system is mandatory.

**Colour**

- silver
- white, sim. to RAL 9016
- stainless steel
- special colour (sim. to RAL)

**Make**

DORMA TS 93 GSR-EMF 2/BG

**TS 93 GSR-EMR 2/BG** EN 2-5

Cam action door closer conforming to EN 1154, carries the CE mark, Contur design, with rapidly decreasing opening torque/force. Push-side fixing. Closing speed, latching speed, hydraulically controlled backcheck and delayed action conveniently adjustable at valves accessible from the front. Mounting bracket with universal fixing hole system. Non-handed. Smoke detector with standby and maintenance indicators, fully integrated in the door co-ordinator body. A floating (voltage-free) alarm contact and connections for further detectors and external manual release devices are provided. Power supply 230 V AC, operating voltage 24 V DC.

Slide channel assembly with integrated mechanical door co-ordinator, conforming to EN 1158. With electro-mechanical hold-open for the active and inactive leaf, 24 V DC, conforming to EN 1155. Hold-open point (80° – 120°) and pull-off force infinitely variable. This system operates independently of the door closer hydraulics using a push rod clamping system with an overload release and one-piece cover. Overall height 30 mm. Non-handed. Approved by the German Institute for Building Technology, Berlin, for use as a hold-open unit. Acceptance inspection of the system is mandatory.

**Model**

- TS 93 GSR-EMR 2/BG  
With integrated electro-mechanical hold-open for the active and inactive leaf.
- TS 93 GSR-EMR 2 DCW<sup>®</sup>/BG  
Smoke detector without power pack for connection to a DCW<sup>®</sup> bus. With integrated electro-mechanical hold-open for the active and inactive leaf.

**Colour**

- silver
- white, sim. to RAL 9016
- stainless steel
- special colour (sim. to RAL)

**Make**

DORMA TS 93 GSR-EMR 2/BG  
DORMA TS 93 GSR-EMR 2 DCW<sup>®</sup>/BG



DORMA GmbH+Co. KG  
DORMA Platz 1  
58256 ENNEPITAL  
GERMANY  
Phone +49 2333 793-0  
Fax +49 2333 793-4950  
[www.dorma.com](http://www.dorma.com)